

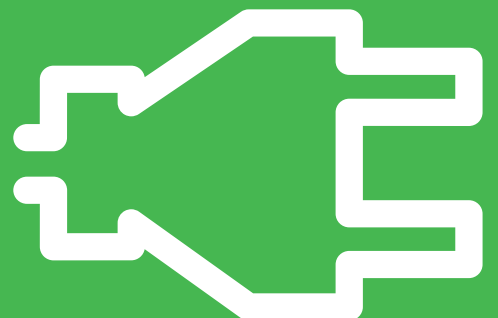

 Price List

Final Distribution, Wiring Devices and Lighting Control Products

With effect from April 01st, 2026



se.com/in

Acti 9 Distribution System	4
Miniature Circuit Breakers (MCBs).....	8
Residual Current Devices (RCDs).....	11
Arc fault Detection Device (AFDD).....	14
Auxiliaries and Accessories for MCBs / RCDs	15
Surge Protection Devices.....	17
Control and Command Products.....	19
ComReady Control and Command Products.....	21
Isobar Distribution System	22
Acti 9 Isobar Pan Assembly	24
Acti 9 Distribution Boards.....	25
Acti 9 Modular Distribution Boards - Metallic.....	29
Timers & Time Switches	36
Kaedra Enclosures	38
Weather Proof	38
PratiKa.....	40
Plugs and Sockets - IP44 / IP67	40
Electra	44
Metal Clad Plugs & Sockets	44
56 Series	45
Plugs and Sockets - IP56 / IP66	45
Wiring Devices	48
LIVIA - Switch to the extra-ordinary.....	49
Miluz Lara	51
Opale - Switches with Satin Finish	55
Unica Pure - Irresistibly Beautiful	57
ZENcelo India - The Revolutionary Full-Flat Switch	65
AvatarOn - It's also a Switch.....	69
Kavacha - Weather Protected Series.....	76
Metal Boxes	77
Smart Home Energy Management System	78
Wiser™.....	82
Surface and Flush Mount Occupancy Sensors.....	83
Dimmable Sensors with Light Regulation.....	83
Wall Mount Sensors.....	84
Hotel - ELV Dual Motion Sensor	84

Acti 9 | Advanced Communication Technology that Inspires

> Protection devices

- Miniature circuit breakers
- Residual current circuit breakers
- Vigi™ residual current devices
- Surge Protection Devices

> Protection monitoring and supervision

- Indication and tripping auxiliaries
- Remote control auxiliaries
- Automatic reclosure auxiliaries



Innovative

Protection monitoring Total control and
Metering @ DB level



Efficient

Manage loads, reduce operating and project
costs, and accurately plan maintenance

> Control and monitoring

- Contactors
- Impulse relays
- Integrated control circuit breakers
- Light indicators
- Push-buttons and selector switches
- Communication Architecture

> Installation system

- IP20B terminals
- Splitter blocks
- Full range of mounting and wiring accessories



Reliable

100 percent MCB and RCD coordination, easy ordering and design, error free fast connections

Acti 9 | Advanced Communication Technology that Inspires.....

> Innovative

- Centralized control system including energy metering
- Large and variable data reading and computing through universal Modbus protocol

> Efficient

- One-click, prefabricated wiring for comprehensive communication between your distribution board or panel and any facility management system

> Reliable

- Error proof connection leading to reduction in downtime
- EMC tested for immunity, radiated and conducted safety

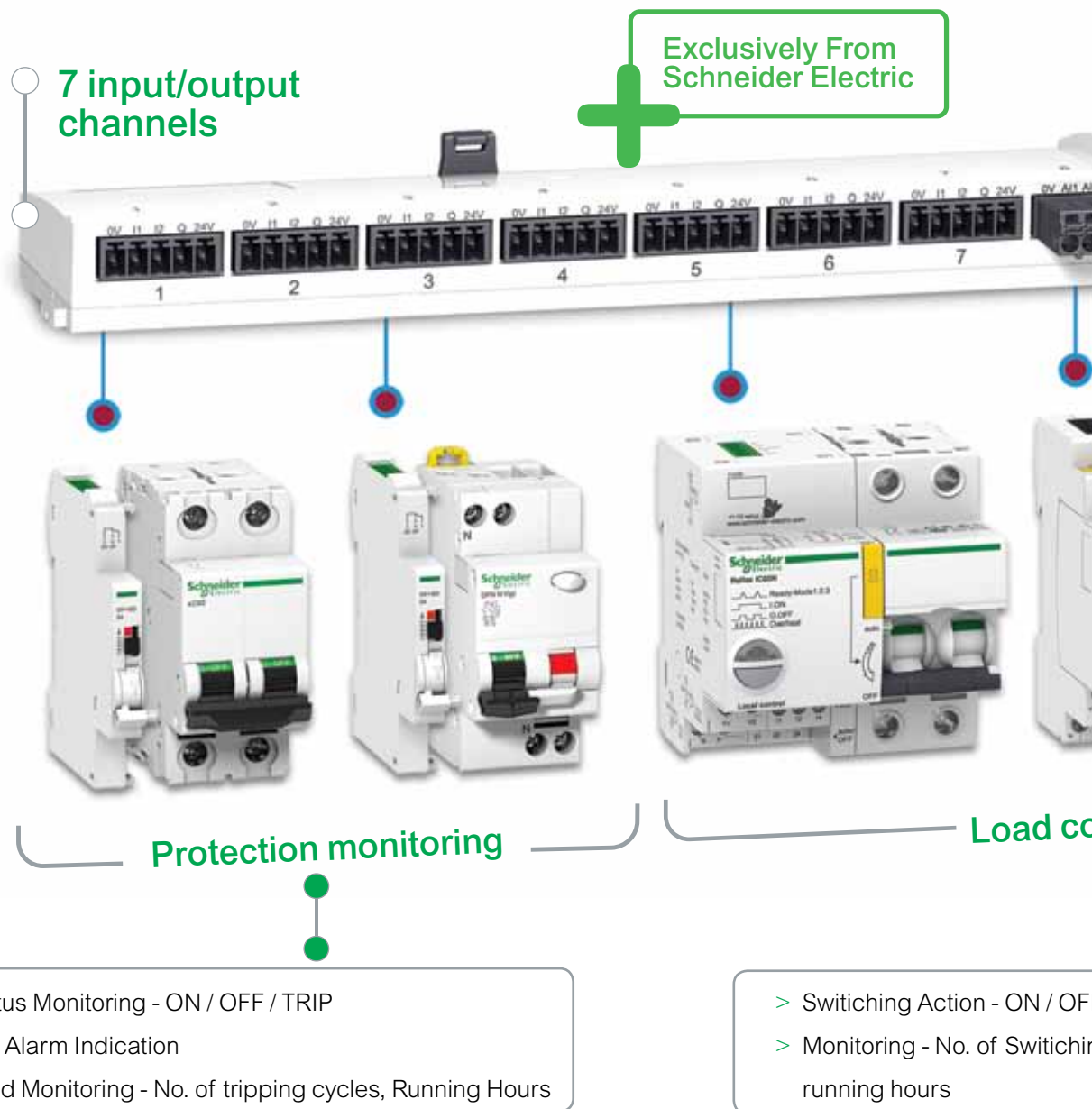

Meets the challenge of all your applications

Detailed load control, reduced downtime and accurately planned maintenance

Ready to connect to any facility management solution

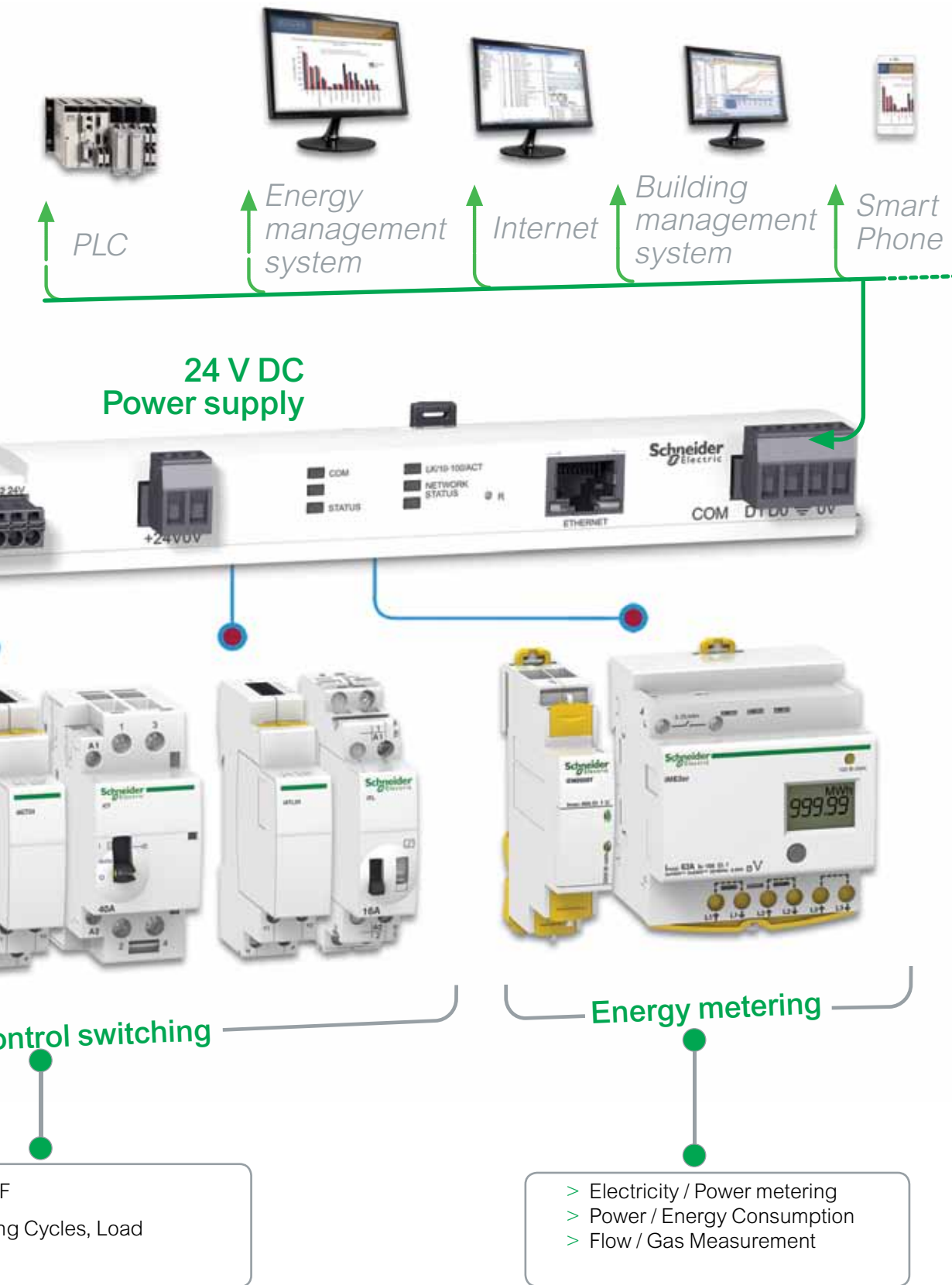

Environmental data program
REACH, RoHS, PEP, EOL compliant

AC Miniature Circuit Breakers - xC60 - IS/IEC 60898-1



- Breaking Capacity as per IEC 60898 and IS/IEC 60898-1, Icn = 10kA
- Can be used for DC application upto 60V per pole
- Higher Installation Life: Energy Limitation Class 3, Fast Closure Mechanism
- Ease, Speed and Flexibility of installation - Biconnect, Line-Load Reversible
- Field-fittable auxiliaries for advance protection and monitoring
- Positive Contact Indication for assurance of disconnection

[In] Rated Current (A)	1 Pole Reference	Unit MRP [₹]	2 Pole Reference	Unit MRP [₹]	3 Pole Reference	Unit MRP [₹]	4 Pole Reference	Unit MRP [₹]
Module Width**	1 mod		2 mod		3 mod		4 mod	
MOQ	12 Nos.		6 Nos.		4 Nos.		3 Nos.	
B curve								
6	A9N1P06BGN ✓	535	A9N2P06BGN ✓	1615	A9N3P06BGN ✓	2678	A9N4P06BGN	3421
10	A9N1P10BGN ✓	535	A9N2P10BGN ✓	1615	A9N3P10BGN ✓	2678	-	-
16	A9N1P16BGN ✓	535	A9N2P16BGN ✓	1615	A9N3P16BGN ✓	2678	A9N4P16BGN	3421
20	A9N1P20BGN ✓	535	A9N2P20BGN ✓	1615	A9N3P20BGN	2678	-	-
25	A9N1P25BGN ✓	535	A9N2P25BGN	1615	A9N3P25BGN ✓	2678	-	-
32	A9N1P32BGN ✓	535	A9N2P32BGN	1615	A9N3P32BGN ✓	2678	A9N4P32BGN	3421
40	A9N1P40BGN ✓	1161	A9N2P40BGN	3506	A9N3P40BGN	3655	A9N4P40BGN	5195
50	A9N1P50BGN	1161	-	-	A9N3P50BGN	3655	-	-
63	A9N1P63BGN ✓	1177	-	-	A9N3P63BGN ✓	4114	A9N4P63BGN	5243
C curve								
1	A9N1P01CGN ✓	820	A9N2P01CGN ✓	2235	A9N3P01CGN ✓	3528	A9N4P01CGN ✓	4440
2	A9N1P02CGN ✓	820	A9N2P02CGN	2235	A9N3P02CGN ✓	3528	A9N4P02CGN ✓	4440
3	A9N1P03CGN ✓	820	A9N2P03CGN ✓	2235	A9N3P03CGN	3528	-	-
4	A9N1P04CGN ✓	820	A9N2P04CGN ✓	2235	A9N3P04CGN ✓	3528	A9N4P04CGN ✓	4440
6	A9N1P06CGN ✓	486	A9N2P06CGN ✓	1615	A9N3P06CGN ✓	2678	A9N4P06CGN ✓	3609
10	A9N1P10CGN ✓	486	A9N2P10CGN ✓	1615	A9N3P10CGN ✓	2678	A9N4P10CGN ✓	3609
16	A9N1P16CGN ✓	486	A9N2P16CGN ✓	1615	A9N3P16CGN ✓	2678	A9N4P16CGN ✓	3609
20	A9N1P20CGN ✓	486	A9N2P20CGN ✓	1615	A9N3P20CGN ✓	2678	A9N4P20CGN ✓	3609
25	A9N1P25CGN ✓	486	A9N2P25CGN ✓	1615	A9N3P25CGN ✓	2678	A9N4P25CGN ✓	3609
32	A9N1P32CGN ✓	486	A9N2P32CGN ✓	1615	A9N3P32CGN ✓	2678	A9N4P32CGN ✓	3609
40	A9N1P40CGN ✓	1161	A9N2P40CGN ✓	2599	A9N3P40CGN ✓	4079	A9N4P40CGN ✓	5243
50	A9N1P50CGN	1161	A9N2P50CGN	2599	A9N3P50CGN	4079	A9N4P50CGN	5243
63	A9N1P63CGN ✓	1177	A9N2P63CGN ✓	2621	A9N3P63CGN ✓	4214	A9N4P63CGN ✓	5460
D curve								
2	A9N1P02DGN ✓	828	A9N2P02DGN ✓	2259	-	-	-	-
3	A9N1P03DGN ✓	828	A9N2P03DGN	2259	A9N3P03DGN ✓	3582	-	-
4	A9N1P04DGN ✓	828	A9N2P04DGN ✓	2259	A9N3P04DGN ✓	3582	-	-
6	A9N1P06DGN ✓	698	A9N2P06DGN ✓	1692	A9N3P06DGN ✓	2821	-	-
10	A9N1P10DGN ✓	698	A9N2P10DGN ✓	1692	A9N3P10DGN ✓	2821	-	-
16	A9N1P16DGN ✓	698	A9N2P16DGN ✓	1692	A9N3P16DGN ✓	2821	A9N4P16DGN ✓	3742
20	A9N1P20DGN ✓	698	A9N2P20DGN ✓	1692	A9N3P20DGN ✓	2821	A9N4P20DGN ✓	3742
25	A9N1P25DGN ✓	698	A9N2P25DGN ✓	1692	A9N3P25DGN ✓	2821	A9N4P25DGN ✓	3742
32	A9N1P32DGN ✓	698	A9N2P32DGN ✓	1692	A9N3P32DGN ✓	2821	A9N4P32DGN ✓	3742
40	A9N1P40DGN ✓	1254	A9N2P40DGN ✓	2747	A9N3P40DGN ✓	4322	A9N4P40DGN ✓	5419
50	-	-	-	-	A9N3P50DGN	4322	-	-
63	A9N1P63DGN ✓	1268	A9N2P63DGN ✓	2780	A9N3P63DGN ✓	4360	A9N4P63DGN ✓	5475

Please contact Customer Care Center for Stockable and Non stockable status of references.

✓ NORMAL STOCK ITEMS

W.E.F. April 01st, 2026

AC Miniature Circuit Breakers - XC60 - IEC - 60947-2



- Breaking Capacity as per IEC 60947-2
 - Icu 15kA - B, C & D Curve: - 1A to 40A
 - Icu 10kA - B & C Curve: - 50 & 63A
 - Icu 6kA - D Curve: - 50 & 63A
- Can be used for DC application upto 60V per pole
- Higher system performance with optimized cost: Cascading*
- Increased System Continuity: Discrimination*
- Higher Installation Life: Energy Limitation Class 3, Fast Closure Mechanism
- Ease, Speed and Flexibility of installation - Biconnect, Line-Load Reversible
- Field-fittable auxiliaries for advance protection and monitoring
- Positive Contact Indication for assurance of disconnection

[In] Rated Current (A)	1 Pole Reference	Unit MRP [₹]	2 Pole Reference	Unit MRP [₹]	3 Pole Reference	Unit MRP [₹]	4 Pole Reference	Unit MRP [₹]
Module Width**	1 mod		2 mod		3 mod		4 mod	
MOQ	12 Nos.		6 Nos.		4 Nos.		3 Nos.	
B curve								
6	A9N1P06BIN <input checked="" type="checkbox"/>	551	A9N2P06BIN <input checked="" type="checkbox"/>	1662	A9N3P06BIN <input checked="" type="checkbox"/>	2759	-	-
10	A9N1P10BIN <input checked="" type="checkbox"/>	551	A9N2P10BIN <input checked="" type="checkbox"/>	1662	A9N3P10BIN <input checked="" type="checkbox"/>	2759	-	-
16	A9N1P16BIN <input checked="" type="checkbox"/>	551	A9N2P16BIN <input checked="" type="checkbox"/>	1662	A9N3P16BIN <input checked="" type="checkbox"/>	2759	-	-
20	A9N1P20BIN <input checked="" type="checkbox"/>	551	A9N2P20BIN <input checked="" type="checkbox"/>	1662	-	-	-	-
25	A9N1P25BIN <input checked="" type="checkbox"/>	551	-	-	A9N3P25BIN <input checked="" type="checkbox"/>	2759	-	-
32	A9N1P32BIN <input checked="" type="checkbox"/>	551	-	-	A9N3P32BIN <input checked="" type="checkbox"/>	2759	A9N4P32BIN <input checked="" type="checkbox"/>	3718
40	A9N1P40BIN <input checked="" type="checkbox"/>	1196	-	-	-	-	A9N4P40BIN <input checked="" type="checkbox"/>	5351
63	A9N1P63BIN <input checked="" type="checkbox"/>	1212	-	-	A9N3P63BIN <input checked="" type="checkbox"/>	4238	A9N4P63BIN <input checked="" type="checkbox"/>	5401
C curve								
1	A9N1P01CIN <input checked="" type="checkbox"/>	845	A9N2P01CIN <input checked="" type="checkbox"/>	2303	A9N3P01CIN <input checked="" type="checkbox"/>	3634	A9N4P01CIN <input checked="" type="checkbox"/>	4573
2	A9N1P02CIN <input checked="" type="checkbox"/>	845	A9N2P02CIN <input checked="" type="checkbox"/>	2303	A9N3P02CIN <input checked="" type="checkbox"/>	3634	A9N4P02CIN <input checked="" type="checkbox"/>	4573
3	A9N1P03CIN <input checked="" type="checkbox"/>	845	A9N2P03CIN <input checked="" type="checkbox"/>	2303	A9N3P03CIN <input checked="" type="checkbox"/>	3634	-	-
4	A9N1P04CIN <input checked="" type="checkbox"/>	845	A9N2P04CIN <input checked="" type="checkbox"/>	2303	A9N3P04CIN <input checked="" type="checkbox"/>	3634	A9N4P04CIN <input checked="" type="checkbox"/>	4573
6	A9N1P06CIN <input checked="" type="checkbox"/>	501	A9N2P06CIN <input checked="" type="checkbox"/>	1662	A9N3P06CIN <input checked="" type="checkbox"/>	2759	A9N4P06CIN <input checked="" type="checkbox"/>	3718
10	A9N1P10CIN <input checked="" type="checkbox"/>	501	A9N2P10CIN <input checked="" type="checkbox"/>	1662	A9N3P10CIN <input checked="" type="checkbox"/>	2759	A9N4P10CIN <input checked="" type="checkbox"/>	3718
16	A9N1P16CIN <input checked="" type="checkbox"/>	501	A9N2P16CIN <input checked="" type="checkbox"/>	1662	A9N3P16CIN <input checked="" type="checkbox"/>	2759	A9N4P16CIN <input checked="" type="checkbox"/>	3718
20	A9N1P20CIN <input checked="" type="checkbox"/>	501	A9N2P20CIN <input checked="" type="checkbox"/>	1662	A9N3P20CIN <input checked="" type="checkbox"/>	2759	A9N4P20CIN <input checked="" type="checkbox"/>	3718
25	A9N1P25CIN <input checked="" type="checkbox"/>	501	A9N2P25CIN <input checked="" type="checkbox"/>	1662	A9N3P25CIN <input checked="" type="checkbox"/>	2759	A9N4P25CIN <input checked="" type="checkbox"/>	3718
32	A9N1P32CIN <input checked="" type="checkbox"/>	501	A9N2P32CIN <input checked="" type="checkbox"/>	1662	A9N3P32CIN <input checked="" type="checkbox"/>	2759	A9N4P32CIN <input checked="" type="checkbox"/>	3718
40	A9N1P40CIN <input checked="" type="checkbox"/>	1196	A9N2P40CIN <input checked="" type="checkbox"/>	2677	A9N3P40CIN <input checked="" type="checkbox"/>	4201	A9N4P40CIN <input checked="" type="checkbox"/>	5401
50	A9N1P50CIN <input checked="" type="checkbox"/>	1196	A9N2P50CIN <input checked="" type="checkbox"/>	2677	A9N3P50CIN <input checked="" type="checkbox"/>	4201	A9N4P50CIN <input checked="" type="checkbox"/>	5401
63	A9N1P63CIN <input checked="" type="checkbox"/>	1212	A9N2P63CIN <input checked="" type="checkbox"/>	2702	A9N3P63CIN <input checked="" type="checkbox"/>	4341	A9N4P63CIN <input checked="" type="checkbox"/>	5625
D curve								
2	A9N1P02DIN <input checked="" type="checkbox"/>	852	A9N2P02DIN <input checked="" type="checkbox"/>	2327	-	-	-	-
3	A9N1P03DIN <input checked="" type="checkbox"/>	852	-	-	A9N3P03DIN <input checked="" type="checkbox"/>	3690	-	-
4	A9N1P04DIN <input checked="" type="checkbox"/>	852	A9N2P04DIN <input checked="" type="checkbox"/>	2327	A9N3P04DIN <input checked="" type="checkbox"/>	3690	-	-
6	A9N1P06DIN <input checked="" type="checkbox"/>	719	A9N2P06DIN <input checked="" type="checkbox"/>	1744	A9N3P06DIN <input checked="" type="checkbox"/>	2907	-	-
10	A9N1P10DIN <input checked="" type="checkbox"/>	719	A9N2P10DIN <input checked="" type="checkbox"/>	1744	A9N3P10DIN <input checked="" type="checkbox"/>	2907	-	-
16	A9N1P16DIN <input checked="" type="checkbox"/>	719	A9N2P16DIN <input checked="" type="checkbox"/>	1744	A9N3P16DIN <input checked="" type="checkbox"/>	2907	A9N4P16DIN <input checked="" type="checkbox"/>	3855
20	A9N1P20DIN <input checked="" type="checkbox"/>	719	A9N2P20DIN <input checked="" type="checkbox"/>	1744	A9N3P20DIN <input checked="" type="checkbox"/>	2907	A9N4P20DIN <input checked="" type="checkbox"/>	3855
25	A9N1P25DIN <input checked="" type="checkbox"/>	719	A9N2P25DIN <input checked="" type="checkbox"/>	1744	A9N3P25DIN <input checked="" type="checkbox"/>	2907	A9N4P25DIN <input checked="" type="checkbox"/>	3855
32	A9N1P32DIN <input checked="" type="checkbox"/>	719	A9N2P32DIN <input checked="" type="checkbox"/>	1744	A9N3P32DIN <input checked="" type="checkbox"/>	2907	A9N4P32DIN <input checked="" type="checkbox"/>	3855
40	A9N1P40DIN <input checked="" type="checkbox"/>	1292	A9N2P40DIN <input checked="" type="checkbox"/>	2830	A9N3P40DIN <input checked="" type="checkbox"/>	4452	A9N4P40DIN <input checked="" type="checkbox"/>	5583
50	-	-	-	-	A9N3P50DIN <input checked="" type="checkbox"/>	4452	A9N4P50DIN <input checked="" type="checkbox"/>	5583
63	A9N1P63DIN <input checked="" type="checkbox"/>	1306	A9N2P63DIN <input checked="" type="checkbox"/>	2864	A9N3P63DIN <input checked="" type="checkbox"/>	4491	A9N4P63DIN <input checked="" type="checkbox"/>	5639

Please contact Customer Care Center for Stockable and Non stockable status of references.

NORMAL STOCK ITEMS

W.E.F. April 01st, 2026

DC Miniature Circuit Breakers - C60H



Suitable for
ComReady
Auxiliary



- Specially designed MCB for enhanced protection in DC installation
- Magnetic Arc Chutes to quick break DC current in event of fault
- Breaking capacity 6kA as per IEC 60947-2
- Voltage Rating: 1P - 250 V DC & 2P - 500 V DC
- Impulse Voltage: 6 kV
- Higher Installation Life: Energy Limiting Class: 3

[In] Rated Current (A)	Module Width 18mm/ module	1 Pole Reference	Unit MRP [₹]	Module Width 18mm/ module	2 Pole Reference	Unit MRP [₹]
MOQ		12 Nos.		6 Nos.		
C60H-DC						
0.5	1	A9N61500	2104	2	A9N61520	4620
1	1	A9N61501 <input checked="" type="checkbox"/>	1535	2	A9N61521 <input checked="" type="checkbox"/>	3167
2	1	A9N61502 <input checked="" type="checkbox"/>	1535	2	A9N61522 <input checked="" type="checkbox"/>	3167
3	1	A9N61503 <input checked="" type="checkbox"/>	1535	2	A9N61523 <input checked="" type="checkbox"/>	3167
4	1	A9N61504 <input checked="" type="checkbox"/>	1535	2	A9N61524 <input checked="" type="checkbox"/>	3167
5	1	A9N61505	1535	2	A9N61525	3167
6	1	A9N61506 <input checked="" type="checkbox"/>	1260	2	A9N61526 <input checked="" type="checkbox"/>	2577
10	1	A9N61508 <input checked="" type="checkbox"/>	1260	2	A9N61528 <input checked="" type="checkbox"/>	2577
16	1	A9N61511 <input checked="" type="checkbox"/>	1260	2	A9N61531 <input checked="" type="checkbox"/>	2577
20	1	A9N61512 <input checked="" type="checkbox"/>	1260	2	A9N61532 <input checked="" type="checkbox"/>	2577
25	1	A9N61513 <input checked="" type="checkbox"/>	1260	2	A9N61533 <input checked="" type="checkbox"/>	2577
32	1	A9N61515 <input checked="" type="checkbox"/>	1453	2	A9N61535 <input checked="" type="checkbox"/>	2577
40	1	A9N61517 <input checked="" type="checkbox"/>	1728	2	A9N61537 <input checked="" type="checkbox"/>	3799
50	1	A9N61518 <input checked="" type="checkbox"/>	1728	2	A9N61538 <input checked="" type="checkbox"/>	3799
63	1	A9N61519 <input checked="" type="checkbox"/>	1728	2	A9N61539 <input checked="" type="checkbox"/>	3799

Special application MCBs



Solar Application – PV DC

- DC MCB for multi string PV installations
- Operating Voltage: 800V DC
- Current Rating up to 25A
- Complies to IEC / EN 60947-2



Rail Application* (including Rolling Stock)

- Shock & vibration resistant (IEC 61373) – Cat 1, Class B
- Complies to EN 45545 HL2
- Complies to IEC / EN 60947-2



UL MCB

- Type: UL1077, UL489
- Breaking Capacity of 10kA
- Complies to IEC 60947-2 / UL1077 / UL489 / CSA

Note:

Please contact nearest Schneider Electric sales office or Customer Care for Reference and prices of Application Specific MCBs

*Rail Application RCDs are also available on demand **18mm/module

Residual Current Devices (RCDs) - For Human and Fire Protection



**30
mA**

Use of **30mA RCDs** is now **mandatory** for all **domestic intallations** in India (NEC 2023)



Schneider Electric provides voltage independent RCDs which work on current sensing technology and provide protection from residual current even at extra low voltages (down to zero volts) and in case of break of neutral.

**SI
Type**

Schneider Electric offers SI RCD built to operate in electrically polluted or installation in aggressive environments:

- Flourescent / Variable lighting with Electronic ballast
- Powerful IT / Telecom equipment / Air conditioning
- Severe Atmosphere - High lighting risk / Swimming pools

* for Measures relating to Safety and Electric supply

AC Residual Current Circuit Breakers - xID



- Complies to IEC/EN 61008-1 and IS 12640
- AC Type
- Selective range available for time based discrimination
- Easy Monitoring: Earth fault indication and Test Button on front face
- Mandatory to use OF-S auxiliary to add any indication or tripping auxiliary

[In] Rated Current (A)	Earth-Leakage Sensitivity (mA)	Module Width 18mm/module	2 Pole Reference	Unit MRP [₹]	Module Width 18mm/module	4 Pole Reference	Unit MRP [₹]
25	30	2	A9N16201	5571	4	A9N16251	7819
	100	2	A9N16203	6183	4	A9N16253	8310
	300	2	A9N16202	6371	4	A9N16252	8555
40	30	2	A9N16204	6558	4	A9N16254	7697
	100	2	A9N16205	7070	4	A9N16255	8356
	300	2	A9N16206	7415	4	A9N16256	8678
63	30	2	A9N16208	7897	4	A9N16258	8913
	100	2	A9N16209	8492	4	A9N16259	9872
	300	2	A9N16210	8663	4	A9N16260	9918
80	30	2	A9N16212	13274	4	A9N16261	15723
	100	2	A9N16213	13496	4	A9N16262	15976
	300	2	-	-	4	A9N16263	16062

AC Residual Current Circuit Breakers (RCCBs) - iID



- Complies to IEC 61008-1
- AC Type
- Degree of pollution: 3 (suitable for industrial environment)
- Electrical ON/OFF indication by using OFSP auxiliary

Poles Description	[In] Rated Current (A)	Earth-Leakage Sensitivity (mA)	Module Width 18mm/module	Reference	Unit MRP [₹]
4P	100	30	4	**A9R11491	On Request
		100	4	**A9R12491	On Request
		30	4	A9R11492	On Request
	125	100	4	A9R12492	On Request
		300	4	A9R14492	On Request

Note: **For 100A RCCB Auxiliary kindly contact Customer Care

AC Residual Current Breaker Overload (RCBO) - DPN N Vigi



- Complies to IEC/EN 61009
- AC Type Tripping characteristics - C curve
- Overvoltage category (IEC 60364): IV
- Suitable for indication & tripping auxiliaries

Poles Description	[In] Rated Current (A)	Earth-Leakage Sensitivity (mA)	Module Width 18mm/module	Reference	Unit MRP [₹]
1P+N	6	30	2	A9N19661	8601
		300	2	A9N19681	8736
	10	30	2	A9N19663	8601
		300	2	A9N19683	8736
	16	30	2	A9N19665	8601
		300	2	A9N19685	8736
	20	30	2	A9N19666	8601
		300	2	A9N19686	8736
	25	30	2	A9N19667	8601
		300	2	A9N19687	8736
	32	30	2	A9N19668	8601
		300	2	A9N19688	8736
	40	30	2	A9N19669	10882
		300	2	A9N19689	11071

Note: Application specific RCDs also available with 10mA, 500mA and 1000mA sensitivities

Please contact nearest Schneider Electric Sales Office or Customer Care Center for Reference and Prices

Please contact Customer Care Center for Stockable and Non stockable status of references.

✓ NORMAL STOCK ITEMS

W.E.F. April 01st, 2026

SI Type Residual Current Circuit Breakers (RCCBs) - xID SI



- Complies to IEC/EN 61008-1
- SI RCCDs offer enhanced immunity against Electrical Disturbances; Polluted and Corrosive environments - Guaranteed performance in harsh operating conditions
- Ensures continuity of supply in networks with:
 - Transient overvoltages
 - Loads generating HF leakage current i.e. harmonics
 - Loads generating continuous leakage current
- Ensures tripping on genuine earth fault in networks with:
 - Pulsating DC components
 - HF applications which "Blinds" (non-tripping) the conventional RCCDs

[In] Rated Current (A)	Earth-Leakage Sensitivity (mA)	Module Width 18mm/module	2 Pole Reference	Unit MRP [₹]	Module Width 18mm/module	4 Pole Reference	Unit MRP [₹]
25	30	2	A9N16234	12960	4	A9N16321	14444
40	30	2	A9N16237	13612	4	A9N16324	14900
63	30	2	A9N16240	14003	4	A9N16327	15298
63	300	2	A9N16246	14109	4	-	-

Vigi Block for xC60 (Add-on RCD Module, 2 & 4 Pole)



- Flexibility to use MCB of any tripping curve to suit applications, ensuring best 3 in 1 protection
- No auxiliary supply required
- AC Class protection
- Degree of pollution: 3 (suitable for industrial environment)
- Immune to nuisance tripping due to transient over voltages

[In] Rated Current (A)	Earth-Leakage Sensitivity (mA)	Module Width 18mm/module	2 Pole Reference	Unit MRP [₹]	Module Width 18mm/module	4 Pole Reference	Unit MRP [₹]
25	30	1.5	A9N26581	10298	3	A9N26595	12995
	100	1.5	A9N26582	11335	3	A9N26596	11540
	300	1.5	A9N26583	11984	3	A9N26597	12420
63	30	2	A9N26611	12459	3.5	A9N26643	12505
	100	2	A9N26612	13194	3.5	A9N26644	13109
	300	2	-	-	3.5	A9N26645	13590

Note: Vigi Block for High Rating up to 125A (C120) and High Breaking Capacity (NG125) available on demand

SI Type Residual Current Breaker Overload (RCBO) - DPN N Vigi SI



- Complies to IEC/EN 61009
- Ensures continuity of supply in networks with:
 - Transient overvoltages
 - Loads generating HF leakage current i.e. harmonics
 - Loads generating continuous leakage current
- Ensures tripping on genuine earth fault in networks with :
 - Pulsating DC components
 - HF applications which "Blinds" (non-tripping) the conventional RCCDs

Poles Description	[In] Rated Current (A)	Earth-Leakage Sensitivity (mA)	Module Width 18mm/module	Reference	Unit MRP [₹]
1P+N	6	30	2	A9N19631	17123
	10	30	2	A9N19632	17123
	16	30	2	A9N19634	17123
		300	2	A9N19644	17123
	25	30	2	A9N19636	17123
	32	30	2	A9N19637	17123
	40	30	2	A9N19638	20275
		300	2	A9N19648	22562

*For Prices, please contact nearest Schneider Electric Sales Office or Customer Care Center are Center for Reference and Prices

Please contact Customer Care Center for Stockable and Non stockable status of references.

NORMAL STOCK ITEMS

W.E.F. April 01st, 2026

Acti 9 Active AFDD

Make active safety your new standard

- Integrated arc fault protection for prevention against electrically ignited fires
- AFDD complies to IEC/EN 62606
- RCD complies to IEC/EN 61009-2-1
- Protection Against Series & Parallel Arc

Acti9 iCV40N VigiARC Active, 30 mA, A-SI type



- Ensures tripping on genuine earth fault in networks with :
 - Pulsating DC components
 - HF applications which "Blinds" (non-tripping) the conventional RCDs
- Available in C Curve Configuration

Poles Description	[In] Rated Current (A)	Earth-Leakage Sensitivity (mA)	Module Width 18mm/module	Reference	Unit LP [₹]
1P+N	6	30	2	A9TDNC606	On Request
	10	30	2	A9TDNC610	On Request
	16	30	2	A9TDNC616	On Request
	25	30	2	A9TDNC625	On Request
	32	30	2	A9TDNC632	On Request
	40	30	2	A9TDNC640	On Request

Acti9 iCV40H VigiARC Active, 30 mA, A-SI type



- Ensures tripping on genuine earth fault in networks with :
 - Pulsating DC components
 - HF applications which "Blinds" (non-tripping) the conventional RCDs
- Available in C Curve Configuration
- Seamless connectivity with Wiser 2.0 & ecostruxre through Panel server

Poles Description	[In] Rated Current (A)	Earth-Leakage Sensitivity (mA)	Module Width 18mm/module	Reference	Unit LP [₹]
1P+N	6	30	2	A9TDND606	On Request
	10	30	2	A9TDND610	On Request
	16	30	2	A9TDND616	On Request
	20	30	2	A9TDND620	On Request
	25	30	2	A9TDND625	On Request
	32	30	2	A9TDND632	On Request

Common Auxiliaries for xC60 / RCDs Range

- Field-fittable auxiliaries (clip fitted) mounted on left side with maximum width of 54mm
- Order: Tripping Auxiliaries (MN first) followed by Indication Auxiliaries (SD first)

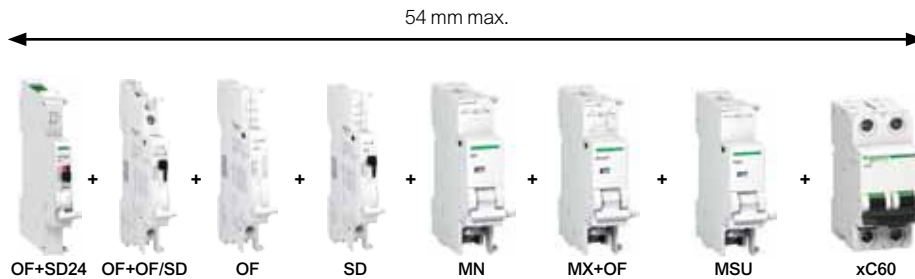

Type	Module Width 18mm/module	Reference	Unit MRP [₹]
Indication Auxiliaries			
Acti9 A9N iOF bottom wiring 0.1-6A aux	0.5	A9N26904	3686
Acti9 A9N SD bottom wiring 0.1-6A aux	0.5	A9N26907	2080
Acti9 A9N OF/SD+OF top/bt wir 0.1-6A aux	0.5	A9N26909	5297
Acti9 A9A iOF bottom wiring 0.1-6A aux	0.5	A9A26904	1837
Acti9 A9A iOF/SD+OF t&b wire 0.1-6A aux	0.5	A9A26909	5628
OF+SD24 auxiliary contact (ComReady)	0.5	A9N26899	4662
Protection Auxiliaries – Trip Indication on front face			
MN Under-voltage Release 220-240V AC	1	A9N26960	7492
MSU Over-voltage Release 275V AC	1	A9N26500	8871
Tripping Auxiliaries – Trip Indication on front face			
MX + OF Shunt Release 110-415V AC: for Remote tripping of Circuit Breaker	1	A9N26946	4873
MX + OF Shunt Release 12-24V AC/DC: for Remote tripping of Circuit Breaker	1	A9N26948	4873
Auxiliary Switch for RCCBs – Mandatory for use of Auxiliaries with RCCBs			
Auxiliary switch for RCCB up to 80A (OF-S)	0.5	A9N26923	8616
Auxiliary switch for RCCBs 125A (OFSP)	0.5	A9N16940	4376

Accessories



Type	Description	Reference	Unit MRP [₹]
Rotary Handle*	Breaker Switching Sub-Assembly	27046	7843
Rotary Handle*	Extended, Disconnectable handle	27047	3960
Padlock** (bag of 2)		26970	1675
Aluminum cable terminal**		27060	986
Spacer		A9N27062	390

* for xC60, C120, DPN N Vigi, C60H-DC, xSW - Multi poles only

Note:

For all above Reference MOQ = 1

Please contact Customer Care Center for Stockable and Non stockable status of references.

NORMAL STOCK ITEMS

W.E.F. April 01st, 2026

Protection Against Lightning Strikes And Switching Surges



For all low voltage switchboards and electrical enclosures:

Comprehensive range

- To ensure the protection of equipment connected to:
- Low voltage networks,
- Telecommunications networks,
- Computer networks.
- Easy to implement and use.
- Compatibility with all earthing systems (TT, TNS, TNC, IT).
- Technical and aesthetic consistency

Continuity of service and certified safety

Schneider Electric certified coordination between the surge arrester and its disconnection circuit breaker.
Compliance with standards: IEC/EN 61643-11.



More and more electrical equipment today is sensitive to overvoltages caused by lightning.



90%

of power outlets supply equipment incorporating electronic devices.



iQuick PRD “built-in” technology surge arresters, a Schneider Electric innovation, incorporate their own disconnection circuit breaker: easy to choose and simple to install for greater effectiveness.



Up to **30%** of installation time saved.

W.E.F. April 01st, 2026

Surge Arresters - Type 1+ 2



- Complies to EN/IEC 61643 -11
- Withdraw able type: Easy Replacement
- Inbuilt SPD health Indicator: Also available with remote signaling
- For protection against Direct lightning surge, Indirect lightning surge, Switching surge
- Iimp up to 25kA & Imax upto 40kA
- **Always use a Back-up MCB with your SPD**
- Maximum Operating Voltage [Uc]: 350V

Type	Pole Description	Module Width 18mm/module	Reference	Unit MRP [₹]
PRD1 25r	1P	2	16329	26716
	1P + N	4	16330	47016
	3P	6	16331	75511
	3P + N	8	16332	93819

Surge Arresters iPRD - Type 2 (Withdrawable type) (TT, TN-S, TN-C Systems)



- Complies to IEC 61643-11/2011 T2 and EN 61643-11
- For protection against Indirect lightning surge and Switching surge
- Inbuilt health Indicator
- Response time < 25ns
- Imax (8/20 s): 65/40/15/8kA
- Maximum Operating Voltage [Uc]: 340V
- Level of protection, Up: 1.0 - 2.0 kV
- Remote indication contact with 8r/20r/40r/65r
- **Always use a Back-up MCB with your SPD**

Type	Rated Voltage (V)	Pole Description	Module Width 18mm/module	Reference	Unit MRP [₹]
iPRD8	230	1P	1	A9L08100	6545
	230	1P+N	2	A9L08500	12484
	230/400	3P	3	A9L08300	16849
iPRD8r	230/400	3P+N	4	A9L08600	25432
	230	1P+N	2	A9L08501	14966
iPRD20	230/400	3P+N	4	A9L08601	30519
	230	1P	1	A9L20100	7335
iPRD20r	230	1P+N	2	A9L20500	15692
	230/400	3P	3	A9L20300	20088
	230/400	3P+N	4	A9L20600	28401
iPRD40	230	1P+N	2	A9L20501	18385
	230/400	3P+N	4	A9L20601	34728
	230	1P	1	A9L40100	9107
iPRD40r	230	1P+N	2	A9L40500	18074
	230/400	3P	3	A9L40300	25943
	230/400	3P+N	4	A9L40600	36176
iPRD65r	230	1P	1	A9L40101	10196
	230	1P+N	2	A9L40501	23300
	230/400	3P	3	A9L40301	34913
	230/400	3P+N	4	A9L40601	43418
iPRD65r	230	1P	1	A9L65101	13631
	230	1P+N	2	A9L65501	29696
	230/400	3P	3	A9L65301	38751
	230/400	3P+N	4	A9L65601	50282

Spare Cartridges for iPRD



- Spare Cartridges for iPRD8r, iPRD20r, iPRD40r and iPRD65r
- End of life indication available on front face
- These Cartridges are not compatible with Old SPD range (A9L16...)**

Type	Spare Cartridges for	Reference	Unit MRP [₹]
iPRD 65-350	iPRD65r	A9L65102	8533
iPRD 40-350	iPRD40, iPRD40r	A9L40102	6894
iPRD 20-350	iPRD20, iPRD20r	A9L20102	5262
iPRD Neutral	All products (1P+N, 3P+N)	A9L00002	7046

**Spare Cartridges for Old SPD Range (A9L16...) are available on demand - please contact nearest Schneider Electric Sales Office or Customer Care for Reference and prices

Note:

For all above Reference MOQ = 1

Please contact Customer Care Center for Stockable and Non stockable status of references.

NORMAL STOCK ITEMS

W.E.F. April 01st, 2026

iQuick PRD - Type 2 with inbuilt MCB



- Compact SPD with in-built back up MCB - saving on space, MCB selection, wiring time
- Complies to EN/IEC 61643-11
- Withdrawable Type - Cost Efficient - Allows damaged Cartridges to be replaced without having to replace entire SPD
- Inbuilt SPD Health Indicator on front face of device; Remote signaling functionality also available
- Incoming Protection: iQuick PRD 40r (High Risk level) and iQuick PRD 20r (Moderate Risk level)
- Secondary Protection: iQuick PRD 8r is cascade mounted with incoming surge arresters

Type	Pole Description	Module Width 18mm/module	Reference	Unit MRP [₹]
iQuick PRD 8r	1P+N	4	A9L16298	18798
	3P	6.5	A9L16299	30401
	3P+N	7.5	A9L16300	37828
iQuick PRD 20r	1P+N	4	A9L16295	23178
	3P	6.5	A9L16296	36495
	3P+N	7.5	A9L16297	45395
Quick PRD 40r	1P+N	4	A9L16292	28990
	3P	6.5	A9L16293	43432
	3P+N	7.5	A9L16294	53977

Note: Spare / Replacement Cartridges available - For Reference and prices contact nearest sales office or customer care

Photovoltaic Surge Arresters



- Protection for photovoltaic panels and the DC input to the inverter from overvoltages due to a lightning strike
- Type 2 surge arresters
- Should be installed in switchboard inside the building. If switchboard is located outside, it must be weatherproof
- Withdrawable surge arrester allows damaged Cartridges to be replaced quickly
- Inbuilt SPD Health Indicator on front face of device; Remote signaling functionality also available

Type	U (cpv) Maximum Operating Voltage (V)	Module Width 18mm/module	Reference	Unit MRP [₹]
iPRD 40r	800	3	A9L40271	14294
	1000	3	A9L40281	17496

Note: Spare / Replacement Cartridges available - For Reference and prices contact nearest sales office or customer care

Surge Arresters for Communication Networks



- Analogue telephone line protection: iPRC surge arrester wired in series to the private installation input, protects the telephones, the modems (including ADSL) etc
- Protection for 2 low-current lines without common potential or 4 lines with common reference potential
- iPRI protects measuring instrument and PLC sensor inputs and the DC power supply inputs up to 53 V and AC power supply inputs up to 37 V

Type	[Ue] Operational Voltage (V)	Module Width 18mm/module	Reference	Unit MRP [₹]
PRI	48 V DC	1	A9L16339	25494
PRC	130 V AC	1	A9L16337	15284

Note:

For all above Reference MOQ = 1

Please contact Customer Care Center for Stockable and Non stockable status of references.

NORMAL STOCK ITEMS

W.E.F. April 01st, 2026

Isolator - xSW



- Complies to IEC/EN 60947-3
- Switching duty: AC - 22A
- Impulse Voltage
 - Upto 80 - 4kV
 - 100 & 125A - 6kV

Poles Description	[In] Rated Current (A)	Module Width 18mm/module	MOQ	Reference	Unit MRP [₹]
2	40	2	6	A9S2P040	1079
	63	2	6	A9S2P063	1426
3	40	3	4	A9S3P040	1885
	63	3	4	A9S3P063	2208
4	40	4	3	A9S4P040	2386
	63	4	3	A9S4P063	2598
	100	4	3	A9S4P100	4347
	125	4	3	A9S4P125	4804

Selector Switch - iSSW



- Complies to IEC 60947-5-1 and IEC 60669-1
- Rating 20A, 250V AC
- Electrical life (AC22): 30,000 cycles
- Connection: tunnel terminals cables up to 10 sq. mm

No. of positions	Poles Description	Contacts	Module Width 18mm/module	MOQ	Reference	Unit MRP [₹]
2	1	1 C/O	1	12	A9E18070	2308
	2	2 C/O	2	6	A9E18071	3173
	2	1NO + 1NC	1	12	A9E18072	1850
3	1	1 C/O	1	12	A9E18073	2118
	2	2 C/O	2	6	A9E18074	3829

iRO Buzzers



- Audible indication in housing and the tertiary sector
- Sound level of 70dBA at a distance of 60cm

Voltage	Module Width 18mm/module	Reference	Unit MRP [₹]
230V AC	1	A9A15322	2852

Please contact Customer Care Center for Stockable and Non stockable status of references.

NORMAL STOCK ITEMS

W.E.F. April 01st, 2026

ICT Contactors



- Complies to IEC 1095, E N 61095
- 4 operating modes switch on front face :
 - Automatic mode
 - Temporary "ON" mode
 - Permanent "ON" mode
 - Shutdown
- Mechanical contact position Indicator
- Safe installation maintenance: lock the contactor in ON position
- Silent operation (20dB) for entire range

Type	Rating (A)	No. of Contacts	Module Width 18mm/module	Reference	Unit MRP [₹]
1P	25	1NO	1	A9C20731	3417
	16	2NO	1	A9C22712	3516
2P	25	2NO	1	A9C20732	4284
	40	2NO	2	A9C20842	9054
	63	2NO	2	A9C20862	9192
3P	25	3NO	2	A9C20833	5418
	40	3NO	2	A9C20843	12028
	63	3NO	3	A9C20863	13072
4P	25	4NO	2	A9C20834	5673
	40	4NO	2	A9C20844	14010
	63	4NO	3	A9C20864	14781
	63	2NO + 2NC	3	A9C20868	17086

Note: 100A Contactor in 2P / 4P - available on request

iTL Impulse Relays



- Complies to IEC/EN 60669-2-2
- Safe maintenance: disconnection of remote control by selector switch
- Manual Controls on front face: 0-I toggle
- Mechanical contact position Indicator
- Maximum 5 operations/min. and 100 switching operations/day
- Degree of pollution: 3 (suitable for industrial environment)

Type	Rating (A)	Control Voltage	No. of Contacts	Module Width	Reference	Unit MRP [₹]
1P	16	230-240 VAC	1NO	1	A9C30811	2299
	32	230-240 VAC	1NO	1	A9C30831	2894
2P	16	230-240 VAC	2NO	1	A9C30812	3633
4P	16	230-240 VAC	4NO	2	A9C30814	7023

iIL Indicator Lights



- Complies to IEC 60947-5-1
- Indicator light with LED technology
- Service life 100,000 hours with constant luminous efficiency

Type	Colour	Module Width 18mm/module	Reference	Unit MRP [₹]
Single Indicator light	Red	1	A9E18320	2291
	Green	1	A9E18321	2291
	Blue	1	A9E18323	2291
	Orange	1	A9E18324	2291
3 phase voltage presence light	Red/Red/Red	1	A9E18327	6742
Single Push Button (1 NO+ 1NC)	Grey	1	A9E18033	3056

Note: For all above Reference MOQ = 1

Please contact Customer Care Center for Stockable and Non stockable status of references.

NORMAL STOCK ITEMS

W.E.F. April 01st, 2026

Communication Auxiliaries



Auxiliary for Protection Devices (OF+SD24) Auxiliary for Contactors (iACT24) Auxiliary for Impulse Relays (iATL24)

Description	Module Width	Reference	Unit MRP [₹]
OF+SD24	0.5	A9N26899	4662
iACT24	1	A9C15924	30147
iATL24	1	A9C15424	22583

Reflex iC60 - Integrated Control & Overcurrent Protection Device



- All in One Solution: MCB + Contactor + Impulse Relay + Auxiliary
- 10kA Breaking capacity as per IEC/EN 60947-2
- Ti24 interface: Connection to PLC, Smartlink
- 3 operating modes to cater to a variety of applications
- Safe lock down with Integrated Padlocking
- Simplified maintenance: Front face Indicator allows better reliability

[In] Rated Current (A)	2 Pole Reference	Unit MRP [₹]	3 Pole Reference	Unit MRP [₹]	4 Pole Reference	Unit MRP [₹]
Module Width **	4.5 mod		5.5 mod		6.5 mod	
B Curve						
10	A9C61210	58998	-	-	-	-
C Curve						
10	A9C62210	62643	A9C62310	67092	-	-
16	A9C62216	62643	A9C62316	64774	A9C62416	67404
25	A9C62225	59652	A9C62325	63498	-	-
40	A9C62240	62828	-	-	A9C62440	73689
63	-	-	-	-	A9C62463	75608

Note: **18mm/module

Please contact Customer Care Center for Stockable and Non stockable status of references.

NORMAL STOCK ITEMS

W.E.F. April 01st, 2026

Isobar Distribution System

EcoStruxure™ Innovation At Every Level

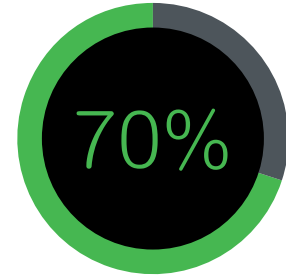

70%
of decision-makers
see the business
value of IoT*

*Schneider Electric IoT 2020
Business Report

From sensors to services, our Innovation At Every Level approach improves energy and operational efficiency by tapping the true business value of IoT advancements. We've made mobility, sensing, cloud, analytics, and cyber security technologies meaningful to customers, helping them compete in our IoT economy.

Connected Products:

The Internet of Things starts with the best things. Our IoT-enabled best-in-class connected products include breakers, drives, UPSs, relays, sensors, and more. Devices with embedded intelligence drive better decision-making throughout operations.

Edge Control:

Mission-critical scenarios can be unpredictable, so control of devices at the edge of the IoT network is a must. This essential capability provides real-time solutions that enable local control at the edge, protecting safety and uptime.

Applications, Analytics, and Services:

Interoperability is imperative to supporting the diverse hardware and systems in building, data center, industry, and grid end markets. EcoStruxure™ enables a breadth of agnostic applications, analytics, and services for seamless enterprise integration.

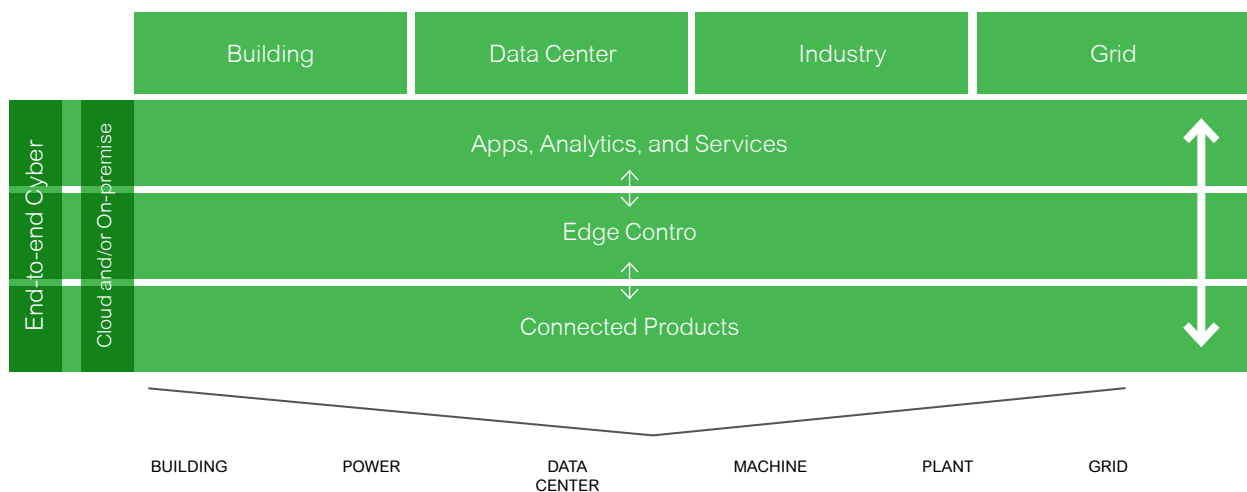

Connectivity built in

Acti9 Isobar harnesses the connectivity of the Acti9 range enabling distribution boards to become smart and connected.



1. **Enable asset management** on all outgoing ways with **PowerTag**



2. **Smartlink SiD** for wireless data concentration



3. **Enable further asset and energy management** through PowerTag for Compact NSX



4. **Monitor and control** your assets with SiB Smartlink



5. See the power and optimise the use of your assets with Facility Expert our **simple on-line services platform**



Acti 9

Isobar Pan Assembly

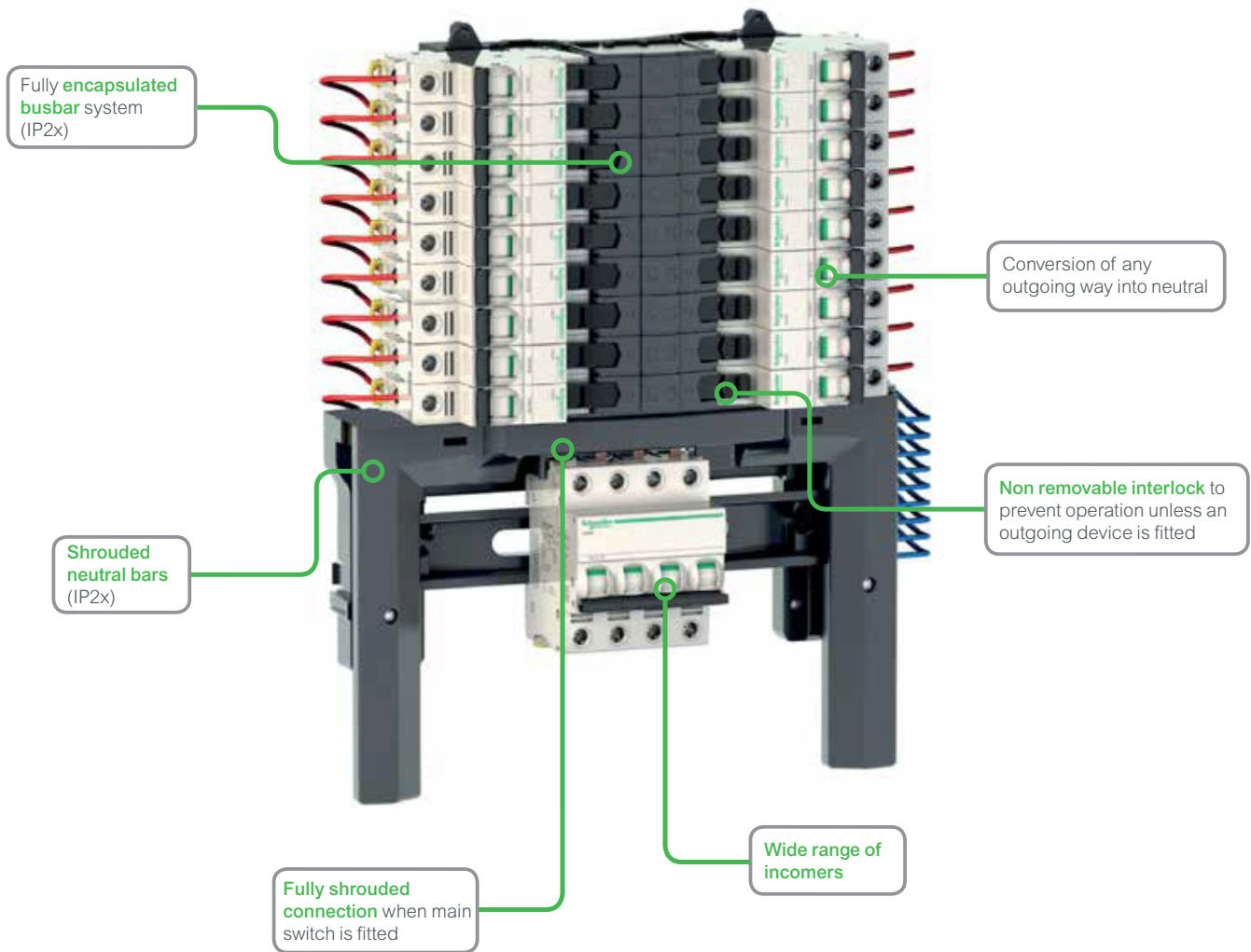

- Fully type tested conditional short circuit rating of 25kA to BS EN 61439-3
- 250A busbar rating
- Range of incomers: switch disconnectors, residual current devices, terminal blocks, MCCB
- Full range of device accessories and auxiliaries
- Shrouded Neutral
- Isobar disconnection conforms to BS/EN 60947-3 ensuring complete isolation for unused poles Option to switch any outgoing to neutral using distributed neutral kit

Description	Double Door Metal (IP43) Reference	Unit LP [₹]
Acti9 Isobar B - pan assembly - 16 ways TP + earth + neutral	SEA9BN16PEV	On Request
Acti9 Isobar B - pan assembly - 18 ways TP + earth + neutral	SEA9BN18PEV	On Request
Acti9 Isobar B - pan assembly - 24 ways TP + earth + neutral	SEA9BN24PEV	On Request
Acti 9 - 1P blank terminal block (no electrical connection)	SEA9BP	On Request
Isobar B - neutral bar - 1N - for distribution board - 16 ways	SEA9NB16	On Request
Isobar B - neutral bar - 1N - for distribution board - 18 ways	SEA9NB18	On Request
Isobar B - neutral bar - 1N - for distribution board - 24 ways	SEA9NB24	On Request
Isobar A - neutral bar - 1N - for distribution board - 4 ways SP+N	SEA9NKIT	On Request
Acti 9 - terminal block - 250A	SEA9NPB250TB	On Request
Acti 9 Isobar B - MCCB/Interpact connection kit	SEA9BINCKIT	On Request

*Price on Request

Please contact Schneider Electric Customer Care Center for Prices

W.E.F. April 01st, 2026

Acti 9

Distribution Boards

Spectacular Design

Blends seamlessly with interiors



Unique Rounded Corners | Color - RAL 9003 white | Designer Rotary Knob

Maximized Wiring Space

Convenient and Safe wiring

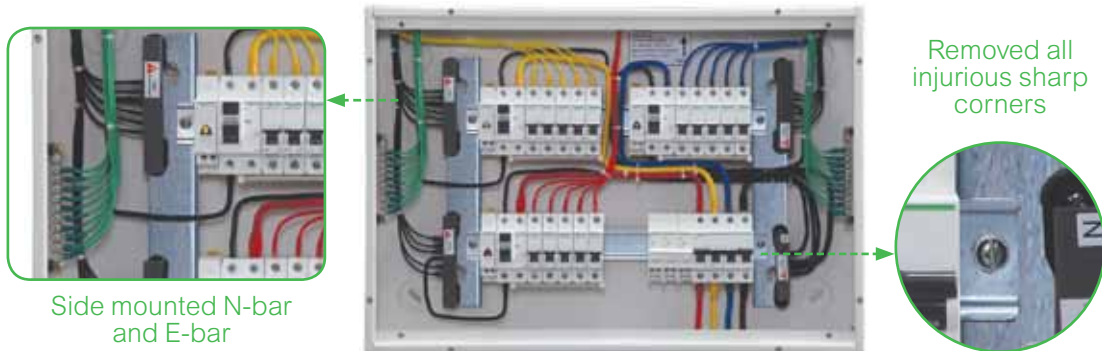

15% more wiring area | Reduced U-box Collar | Removable Frame, Centre plate & Gland plate

Adaptable

Total Flexibility for ease of installation and usage



Surface and Flush installation | Field fittable key lock provision | Reversible Door

Inspiring the **S.M.A.R.T.** choice!!!

Robust Architecture

Perfect blend of Strength & Weight



High Strength-to-Weight ratio | RoHS and REACH Compliance – ideal solution for GREEN Buildings

Base Material used - Galvanized Iron

4X Rust Resistance

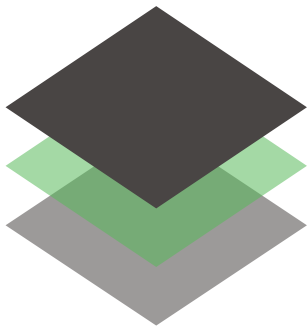

1. Powder Coating
- 2. Galvanized Iron**
3. Base Iron

Galvanized Iron | Gives 4X rust resistance
No Rusting | Even if the powder coating is scratched
No Propagation Of Rust | Even If base material is chipped off
No Hassle | of repainting due to rusting

Inspiring the **S.M.A.R.T.** choice!!!

Technically Proven

Safety Guaranteed



Designed and Manufactured as per **IS 8623 - 1 & 3** | IP and IK test by ERDA & CPRI | Glow wire tested

Type Tested as per IEC 61439 - 1 & 3



IEC 61439 - 3* Fully Compliant

*Tested at **NABL** and **ASTA** accredited testing facility



Salt Spray



IP43



IK09



Reliable Door



Earthing



Temp@
Max Curr

Mechanical Tests

Electrical Tests

W.E.F. April 01st, 2026

Acti 9

Distribution Boards

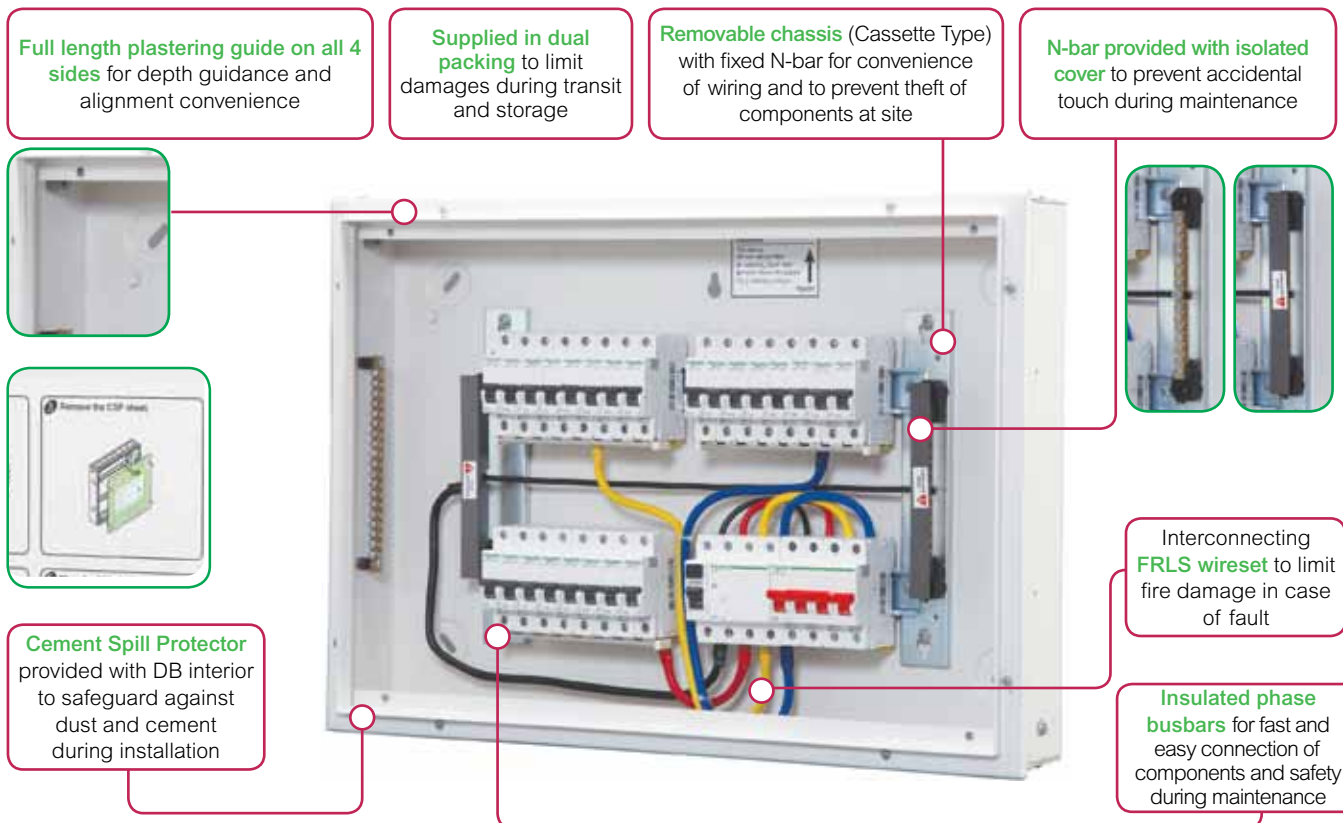
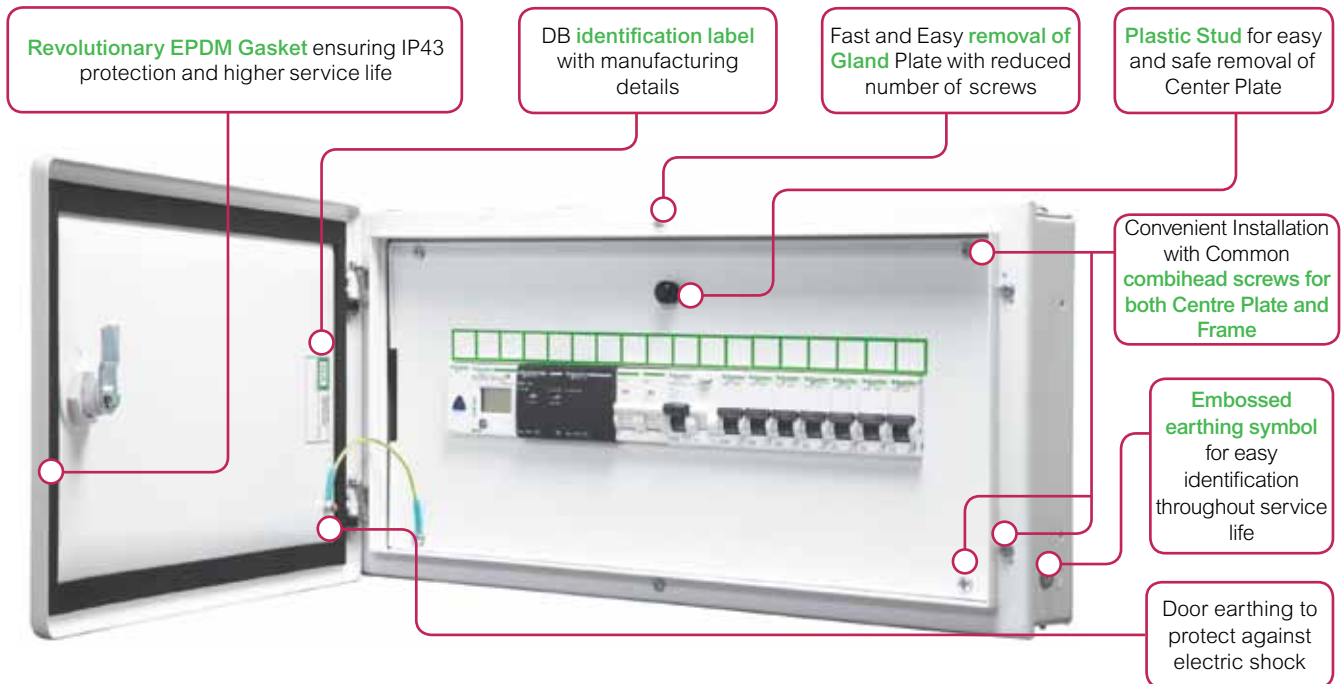

Metal Enclosures



- Metal Enclosure to mount individual Modular Device feeding directly to the load or final distribution board

Description	Total Module Cutout	Single Door (IP30) Reference	Unit MRP [₹]
2 way	1 / 2	A9HMES02 <input checked="" type="checkbox"/>	1233
4 way	3 / 4	A9HMES04 <input checked="" type="checkbox"/>	1233

SPN DBs



- SPN DB for distribution of Single Phase Neutral supply to respective load MCBs
- Incomer - DP RCCB/RCBO/Isolator/MCB
- Outgoing - SP MCBs

Description	Total Module Cutout (Incomer + Outgoing)	Single Door (IP30) Reference	Unit MRP [₹]	Double Door Metal (IP43) Reference	Unit MRP [₹]
6 way	6	A9HSNS06	2387	A9HSND06 <input checked="" type="checkbox"/>	3429
8 way	8	A9HSNS08 <input checked="" type="checkbox"/>	2831	A9HSND08 <input checked="" type="checkbox"/>	3738
12 way	12	A9HSNS12	3350	A9HSND12 <input checked="" type="checkbox"/>	4495
18 way	18	-	-	A9HSND18 <input checked="" type="checkbox"/>	6022

TPN DBs



- Standard TPN DBs for distribution of Three Phase and Neutral supply
- Incomer - FP RCCB/RCBO/Isolator/MCB
- Outgoing - SP MCBs

Description	Total Module Cutout (Incomer + Outgoing)	Single Door (IP30) Reference	Unit MRP [₹]	Double Door Metal (IP43) Reference	Unit MRP [₹]
4 way eco	4 + 12	-	-	A9HTND04E <input checked="" type="checkbox"/>	8947
4 way	8 + 12	-	-	A9HTND04 <input checked="" type="checkbox"/>	9024
6 way	8 + 18	-	-	A9HTND06 <input checked="" type="checkbox"/>	9159
8 way	8 + 24	-	-	A9HTND08 <input checked="" type="checkbox"/>	11294
12 way	8 + 36	-	-	A9HTND12 <input checked="" type="checkbox"/>	17242

Flexi Tier DBs



- Flexi DBs give total flexibility to mount any type and size of Modular devices as per load requirement
- Provided with N-Bar and E-Bar
- Flexi Tier DBs can be converted to PPI DB using 'PPI Kit' provided on next page

Description	Total Module Cutout (Incomer + Outgoing)	Single Door (IP30) Reference	Unit MRP [₹]	Double Door Metal (IP43) Reference	Unit MRP [₹]
2 Tier 24 Modules	2 x 12	-	-	A9HFD224	9671
3 Tier 36 Modules	3 x 12	-	-	A9HFD336	11615
4 Tier 40 Modules	4 x 10	-	-	A9HFD440 <input checked="" type="checkbox"/>	12271
4 Tier 56 Modules	4 x 14	-	-	A9HFD456 <input checked="" type="checkbox"/>	12825

Note:

For all above Reference MOQ = 1
Please contact Customer Care Center for Stockable and Non stockable status of references.

NORMAL STOCK ITEMS

W.E.F. April 01st, 2026

Acti 9

Distribution Boards

New Phase Segregated DBs

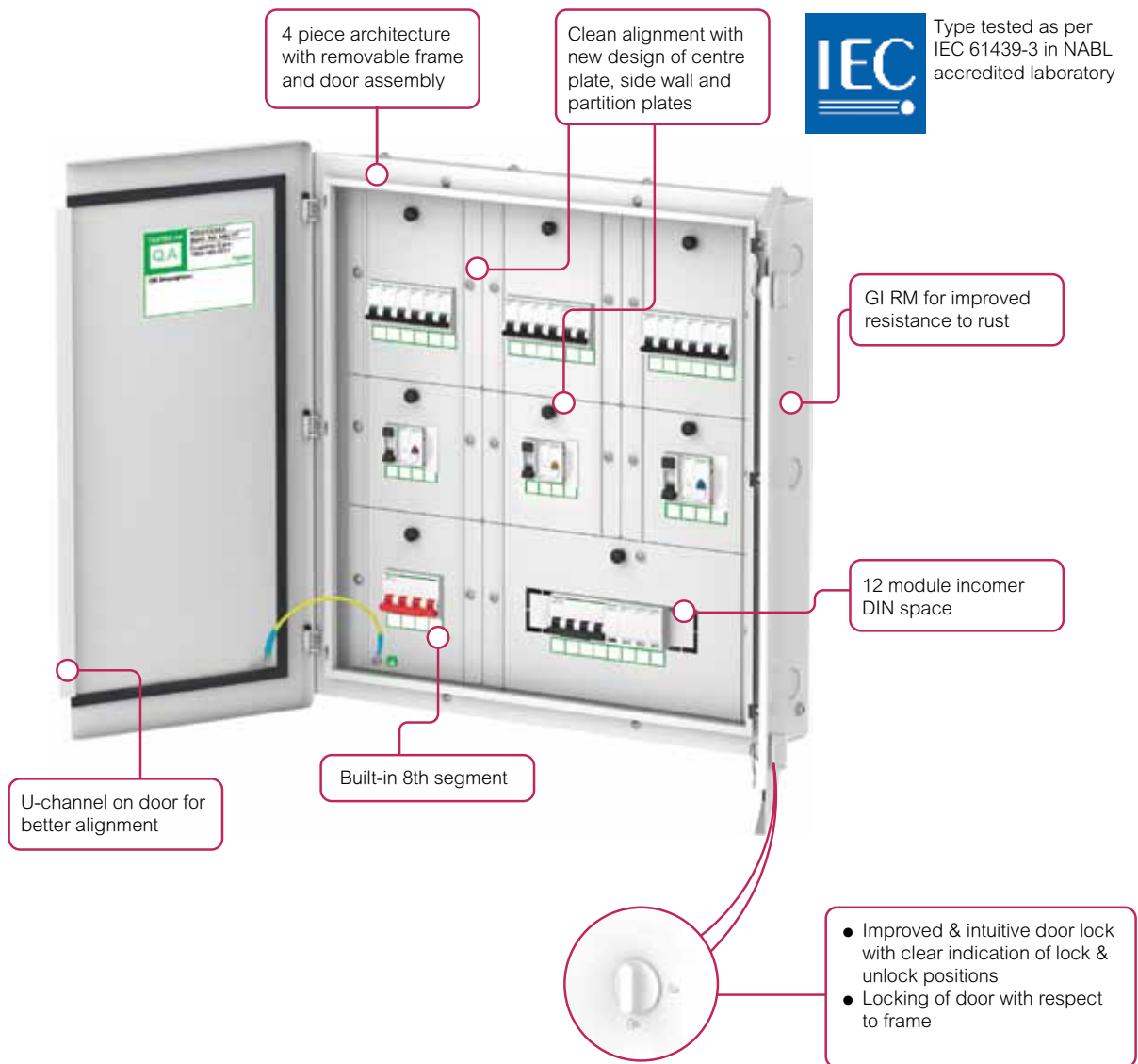

Key highlights

- 1 New compact design
- 2 Robust architecture
- 3 Type-tested system
- 4 4 piece construction
- 5 Built-in 8th segment
- 6 Split door for all variants
- 7 Clean alignment of doors, centerplates
- 8 Improved door locking
- 9 High rust resistance with GI
- 10 Increased incomer DIN space

W.E.F. April 01st, 2026

Per Phase Isolation DBs

- PPI DBs to mount DP Residual Current Device (RCD) at an individual phase level to isolate the faulty phase in case of earth leakage and ensure continuity of supply to other healthy phases
- Incomer - Modular (FP MCB/Isolator) MCCB100A (TP/FP Compact NSX or EasyPact CVS)
- Sub-Incomer - DP RCCB/RCBO
- Outgoing - SP MCBs

PPI TPN DB



Description	Total Module Cutout (no. of rows x No. of modules per row)	Double Door Metal (IP43)	No of Ways	Unit MRP [₹]
6 Way TPN PPI DB	8 + 2 x 3 + 4 x 3	A9HTPI06	6 Ways	11911
8 Way TPN PPI DB	8 + 2 x 3 + 6 x 3	A9HTPI08	8 Ways	13816
12 Way TPN PPI DB	8 + 2 x 3 + 10 x 3	A9HTPI12	12 Ways	19007

PPI Flexi Tier DB

Description	Total Module Cutout (no. of rows x No. of modules per row)	Double Door Metal (IP43)	No of Ways	Unit MRP [₹]
4T40M Flexi PPI DB	4 x 10	A9HFP110	10	18445
4T56M Flexi PPI DB	4 x 14	A9HFP114	14	20768

Phase Segregated DBs



- Phase Segregated DBs to provide total safety for installer and maintenance personnel, by compartmentalizing each Phase and separating Incomer, Sub-Incomer and Outgoing
- Offers better continuity of supply in case of faults during maintenance at DB level.
- Incomer - Modular (FP MCB/Isolator) / MCCB 100A (TP/FP during maintenance Compact NSX or EasyPact CVS)
- Sub-Incomer - DP RCCB/RCBO
- Outgoing - SP MCBs
- GI sheet ensures improved rust resistance
- Type-tested system conforming IEC 61439-3
- Built-in 8th segment (for modular incomer only)
- Increased incomer DIN space of 12M for 6 ways to 12 ways
- Split door for all variants
- New design ensures clean alignment of doors, centerplates
- 4 piece architecture with removable frame
- Improved, intuitive door lock design with clear indication of lock and unlock positions

Description	Total Module Cutout (Additional segment + Incomer + Sub-incomer + Outgoing)	Double Door Metal (IP43) Reference	Unit MRP [₹]
4 way	4 + 8 + (3*4) + (3*4)	A9HPSG04	17964
6 way	4 + 12 + (3*4) + (3*6)	A9HPSG06	20086
8 way	4 + 12 + (3*4) + (3*8)	A9HPSG08	22428
12 way	4 + 12 + (3*4) + (3*12)	A9HPSG12	28154
12 way with MCCB I/c	0 + 100A MCCB + (3*4) + (3*12)	A9HPSG12M	37990

Note:

For all above Reference MOQ = 1
Please contact Customer Care Center for Stockable and Non stockable status of references.

VTPN DBs for Modular Incomer



- Ideal solution to distribute power supply to both 3 Phase and 1 Phase loads in the same DB
- Incomer - FP RCCB / RCBO / Isolator / MCB
- Outgoing - SP MCBs / TP MCBs
- 65% more Incomer Wiring Space.
- New Compact Fishbone with better Thermal Performance
- Short Circuit Withstand – 17 kA for 250mS (100 A)/ 25 kA (250 A) for 500mS
- Secure Connections with Fixed Spreader links
- IP 2X protection at Incomer with new shrouds
- Type tested as per IEC 61439 – 3 in NABL accredited Lab
- Knockout size for Incomer increased to 50mm (to accommodate Aluminium Cable)

Description	Total Module Cutout (Incomer + Outgoing)	Double Door Metal (IP43) Reference	No of Ways	Unit MRP [₹]
Acti9 VTPN DB 4 Ways Modular i-c 63A	12 + 12	A9HVM04	4 Ways	17480
Acti9 VTPN DB 8 Ways Modular i-c 63A	12 + 24	A9HVM08	8 Ways	22244
Acti9 VTPN DB 12 Ways Modular i-c 63A	12 + 36	A9HVM12	12 Ways	29758

VTPN DBs for MCCB Incomer



- DBs for higher incoming current distribution up to 250A
- Incomer - TP/FP Compact NSX or EasyPact CVS MCCB up to 250A
- Outgoing - SP MCBs / TP MCBs
- 65% more Incomer Wiring Space.
- New Compact Fishbone with better Thermal Performance
- Short Circuit Withstand – 17 kA for 250mS (100 A)/ 25 kA (250 A) for 500mS
- Secure Connections with Fixed Spreader links
- IP 2X protection at Incomer with new shrouds
- Type tested as per IEC 61439 – 3 in NABL accredited Lab
- Knockout size for Incomer increased to 50mm (to accommodate Aluminium Cable)

Description	Total Module Cutout (Incomer + Outgoing)	Double Door Metal (IP43) Reference	No of Ways	Unit MRP [₹]
Acti9 VTPN DB 4 Ways MCCB i-c 100A	100 A MCCB + 12	A9HVN04L	4 Ways	19141
Acti9 VTPN DB 4 Ways MCCB i-c 160A	160 A MCCB + 12	A9HVN04M	4 Ways	21074
Acti9 VTPN DB 8 Ways MCCB i-c 100A	100 A MCCB + 24	A9HVN08L	8 Ways	24260
Acti9 VTPN DB 8 Ways MCCB i-c 160A	160 A MCCB + 24	A9HVN08M	8 Ways	26252
Acti9 VTPN DB 8 Ways MCCB i-c 250A	250 A MCCB + 24	A9HVN08H	8 Ways	33655
Acti9 VTPN DB 12 Ways MCCB i-c 100A	100 A MCCB + 36	A9HVN12L	12 Ways	32250
Acti9 VTPN DB 12 Ways MCCB i-c 160A	160 A MCCB + 36	A9HVN12M	12 Ways	35034
Acti9 VTPN DB 12 Ways MCCB i-c 250A	250 A MCCB + 36	A9HVN12H	12 Ways	39811

Mivan Compatible DB

SPN DBs

Description	Total Module Cutout (Incomer + Outgoing)	Double Door Metal (IP43) Reference	No of Ways	Unit MRP [₹]
Acti9 DB 6 way SPN DD 1.6mm	2 + 4	A9HSND06Z	6 Ways	On Request
Acti9 DB 8 way SPN DD 1.6mm	2 + 6	A9HSND08Z	8 Ways	On Request
Acti9 DB 12 way SPN DD 1.6mm	2 + 10	A9HSND12Z	12 Ways	On Request
Acti9 DB 18 way SPN DD 1.6mm	2 + 16	A9HSND18Z	18 Ways	On Request

TPN DBs

Description	Total Module Cutout (Incomer + Outgoing)	Double Door Metal (IP43) Reference	No of Ways	Unit MRP [₹]
Acti9 DB 4 way TPN DD 1.6mm	8 + 4 x 3	A9HTND04Z	4 Ways	On Request
Acti9 DB 6 way TPN DD 1.6mm	8 + 6 x 3	A9HTND06Z	6 Ways	On Request
Acti9 DB 8 way TPN DD 1.6mm	8 + 8 x 3	A9HTND08Z	8 Ways	On Request
Acti9 DB 12 way TPN DD 1.6mm	8 + 12 x 3	A9HTND12Z	12 Ways	On Request

Please contact Customer Care Center for Stockable and Non stockable status of references.

NORMAL STOCK ITEMS

W.E.F. April 01st, 2026

Phase Segregated DBs (Mivan Compatible)

Description	Total Module Cutout (Additional segment + Incomer + Sub-incomer + Outgoing)	Double Door Metal (IP43) Reference	No of Ways	Unit MRP [₹]
Acti9 DB 4 way PSG DD 1.6mm	4 + 8 + (3*4) + (3*4)	A9HPSG04Z	4 ways	On Request
Acti9 DB 6 way PSG DD 1.6mm	4 + 12 + (3*4) + (3*6)	A9HPSG06Z	6 ways	On Request
Acti9 DB 8 way PSG DD 1.6mm	4 + 12 + (3*4) + (3*8)	A9HPSG08Z	8 ways	On Request
Acti9 DB 12 way PSG DD 1.6mm	4 + 12 + (3*4) + (3*12)	A9HPSG12Z	12 ways	On Request

Flexi Tier DBs (Mivan Compatible)

Description	Total Module Cutout (no. of rows x No. of modules per row)	Double Door Metal (IP43) Reference	No of Modules Per Row	Unit MRP [₹]
4 Tier 40 Modules	4 x 10	A9HFD440Z	10	On Request
4 Tier 56 Modules	4 x 14	A9HFD456Z	14	On Request

TV TEL DB

Description	Double Door Metal (IP30) Reference	Unit MRP [₹]
Acti9 DB TVTEL BOX 1mm IP30	A9HTVTEL	On Request
Acti9 DB TVTEL & ONT BOX 1.2MM IP30	A9HOTVTEL	On Request

Note: For all above Reference MOQ = 1

Metal Clad P&S Units

- Plug & Socket Unit with Electra Plug & Socket and provision to mount modular protection devices to feed the end load directly

Description	Total Module Cutout	Single Door (IP30) Reference	Unit MRP [₹]
10A 1P+N+E P&S	2	A9HMS210	3137
20A 1P+N+E P&S	2	A9HMS220	3357
30A 3P+E P&S	3	A9HMS330	7349

Please contact Customer Care Center for Stockable and Non stockable status of references.

NORMAL STOCK ITEMS

W.E.F. April 01st, 2026

Industrial P&S Units (provision to mount PratiKa Sockets)



- Plug & Socket Unit with provision to mount PratiKa straight / angled* socket and modular protection devices to feed the end load directly

Description	Total Module Cutout	Single Door (IP30) Reference	Unit MRP [₹]
16A 3P PK P&S	2	A9HKS316	2901
32A 3P PK P&S	2	A9HKS332	4791
32A 5P PK P&S	4	A9HKS532	5674
63A 5P PK P&S	4	A9HKS563	11458

Locks for Acti 9 DBs

Key Lock*



Lock & Unlock symbol on door for easy & intuitive operation

Description	Reference	Unit MRP [₹]
New Rotary Lock**	A9HRL901	934
New Key Lock**	A9HRL902	870

Note: **Use New Rotary lock reference A9HRL901 for:
Acti9 DBs manufactured September 2020 onwards
Acti9 DBs with lock & unlock symbol on door.

Please contact Customer Care Center for Stockable and Non stockable status of references.

☑ NORMAL STOCK ITEMS

W.E.F. April 01st, 2026

Accessories for Distribution Boards

Wire Way Box for Double Door IP43 DBs

Description	Reference	Unit MRP [₹]
Wire way box for A9HSND06	A9HSND06WB	2309
Wire way box for A9HSND08	A9HSND08WB	2791
Wire way box for A9HSND12	A9HSND12WB	3112
Wire way box for A9HSND18	A9HSND18WB	4444
Wire way BOX FOR A9HTND04E	A9HTND04EWB	3207
Wire way box for A9HTND04	A9HTND04WB	3546
Wire way box for A9HTND06	A9HTND06WB	3760
Wire way box for A9HTND08	A9HTND08WB	4444
Wire way box for A9HTND12	A9HTND12WB	5191
Wire way BOX FOR A9HFD224	A9HFD224WB	3306
Wire way BOX FOR A9HFD336	A9HFD336WB	3273
Wire way BOX FOR A9HFD440	A9HFD440WB	3164
Wire way BOX FOR A9HFD456	A9HFD456WB	3546
WWB Acti9 PSG DB 8 Seg 4 Ways MCB i/c	A9HPSG04WWB	4574
WWB Acti9 PSG DB 8 Seg 6 Ways MCB i/c	A9HPSG06WWB	5352
WWB Acti9 PSG DB 8 Seg 8 Ways MCB i/c	A9HPSG08WWB	5988
WWB Acti9 PSG DB 8 Seg 12 Ways MCB i/c	A9HPSG12WWB	7761
WWB Acti9 PSG DB 7 Seg 12 Ways MCCB i/c	A9HPSG12MWWB	8289
WWB for Std VTPN DB MCB i/c	A9HVMXXWB	3364
WWB for Std VTPN DB MCCB i/c	A9HVNXXWB	3581

Busbars & Accessories

Description	Reference	Unit MRP [₹]
Busbars		
Fork Busbar 1P 12MOD. 63A	R9XFH112	1348
Fork Busbar 1P 57MOD. 63A	R9XFH157	3000
Fork Busbar 2P 12MOD. 63A	R9XFH212	1553
Fork Busbar 2P 57MOD. 63A	R9XFH257	5753
Fork Busbar 3P 12MOD. 63A	R9XFH312	3506
Fork Busbar 3P 57MOD. 63A	R9XFH357	12548
Fork Busbar 4P 12MOD. 63A	R9XFH412	3233
Fork Busbar 4P 57MOD. 63A	R9XFH457	13504
Busbar Accessories		
Set of 10 End Caps 1P	R9XE110	*
Set of 10 End Caps 2P	R9XE210	*
Set of 10 End Caps 3P	R9XE310	*
Set of 10 End Caps 4P	R9XE410	*
Set of 20 Tooth Caps	R9XT20	*
Blanking Plate	13229B	66

Note: Blanking Plate MOQ = 10, All other MOQ = 1

Customized Distribution Boards to Suit Your Need - Available on Request*

- TV/Telephone DBs
- Pre-Wired DBs
- 8 Segment DBs
- Acrylic Door DBs
- IP54 DBs
- DBs with Phase Indication Lamps

*upto 32A socket only

*Please contact nearest Schneider Electric Sales Office or Customer Care Center for coordination chart

Please contact Customer Care Center for Stockable and Non stockable status of references.

NORMAL STOCK ITEMS

W.E.F. April 01st, 2026

Timers & Time Switches

Analog Time Switches



- 24H, 7D Programmable switch Voltage Rating: 230V AC +10%, -15%
- Memory: Upto 56 Switching Operations
- Back up of program: Operating reserve for 100, 200 Hours
- Overall dimensions: 5 modules
- Minimum time between two switching operations: 15, 30 min
- Accuracy: $\leq \pm 1$ s/day at +20°C

Description	Module Width 18mm/module	Reference	Unit MRP [₹]
IH 24H 16 A 15 mts interval 1 channel	1	15336	6845
IH 24H 16 A 30 mts interval 1 channel	1	CCT15365	7466
IH 7 day 16 A 1 channel- Max 21 On and 21 Off cycles	3	CCT15367	10688
IH 24H 16 A 30 mts 1 channel without reserve	3	CCT16364	6064

Digital Time Switches



- 7D, 24H Programmable switch .Voltage Rating: 230V AC +10%, -15%
- Consumption: 1 channel - max. 4VA; 2 channels - max. 7VA
- Memory: Upto 56 Switching Operations
- Back up of program & time by lithium battery: Operating reserve: 6 Years
- Overall dimensions: 5 modules
- Cable length: 100m
- Minimum time between two switching operations: 1 min

Description	Module Width 18mm/module	Reference	Unit MRP [₹]
IHP 1C w (24h/7d) programmable time switch	2.5	CCT15441	14712
IHP+ 1C (24h/7d) SMARTw programmable time switch	2.5	CCT15551	18149
IHP 2C w (24h/7d) programmable time switch	2.5	CCT15443	18978
IHP DCF (24h/7d) SMART programmable time switch	2.5	CCT15858	29875
IHP+ 2C (24h/7d) SMARTw programmable time switch	2.5	CCT15553	20996

Timers



- Switching capacity 16 A, max
- Delay range from 30 sec to 20 min
- Capacity for lighted pushbutton 150 mA
- Electric distribution busbar compatibility
- Output power capacity CCT15232-2300W
- Output power capacity CCT15223-3600W

Description	Module Width 18mm/module	Reference	Unit MRP [₹]
MINs - electronic timer - 0.5 to 20 min	1	CCT15232	8311
MINs - electronic timer - 0.5 to 20 min with switch Off Warning	1	CCT15233	10671
MINs - electronic timer - 0.5 to 20 min with switch Off Warning and Impulse relay function	1	CCT15234	10031

Please contact Customer Care Center for Stockable and Non stockable status of references.

W.E.F. April 01st, 2026

Timers & Time Switches

Twilight switch



- Includes wall mounted cell
- Adjustable brightness threshold 2 to 2000 Lux
- 2 LEDs to signal the sensor status and the output status
- Test button: To check the product and load cabling
- Switching capacity: 16Amp
- Screwless Terminals compatible with rigid and flexible wires
- Consumption 6 VA
- Size 45mm

Description	Module Width 18mm/module	Reference	Unit MRP [₹]
IC2000 outdoor (2 - 2000 lux) twilight switch	1	CCT15369	17527
Analogue indoor light sensor cell	-	CCT15262	8649
Wall mounted Analogue outdoor light sensor cell	-	CCT15263	13406
IC100 (2 - 100 lux) twilight switch	1	CCT15482	14744
IC2000 indoor (2 - 2000 lux) twilight switch	1	CCT15285	13140
IC2000p+ (2 - 2000 lux) programmable twilight switch	2.5	CCT15483	30455
IC100kp+ 1C (1 - 99000 lux) SMART programmable twilight switch	2.5	CCT15494	36834
IC100kp+ 2C (1 - 99000 lux) SMART programmable twilight switch	2.5	CCT15495	45346
IC Astro 2C SMART programmable twilight switch	2.5	CCT15245	31834
IC Astro 1C SMART programmable twilight switch	2.5	CCT15225	26787

Time switch accessories

Description	Module Width 18mm/module	Reference	Unit MRP [₹]
Programming kit for IHP / IC	1	CCT15860	14012

Thermostat

Description	Module Width 18mm/module	Reference	Unit MRP [₹]
THP1+ 1C (24h/7d) programmable thermostat	2.5	CCT15834	31874

Please contact Customer Care Center for Stockable and Non stockable status of references.

W.E.F. April 01st, 2026

Kaedra enclosures for PratiKa industrial sockets are part of a complete system of Watertight enclosures from 16A to 125A providing solutions for protection, control and electrical distribution for tertiary and industrial applications



- Degree of protection - IP65
- Impact strength - IK09
- Resistant to chemical and atmospheric agents, UVs etc.
- Self extinguishing class 2 insulating material
- Flame and abnormal heat resistance: 650°C
- Reversible front face for opening of door to left/right
- Combining of enclosures horizontally/vertically while still maintaining IP
- DIN channel can be positioned in 2 depths & 2 heights for cabling purpose

Mini Enclosures for modular devices



Description	Reference	Unit MRP [₹]
4 module	13441 <input checked="" type="checkbox"/>	4984
6 module	13442	5672
8 module	13443	6679
12 module	13444	10732

Enclosures for modular devices (with terminal blocks)



Description	Reference	Unit MRP [₹]
1 row 12 module	13431	11844
1 row 18 module	13432	15610
2 row 24 module	13433	17727
2 row 36 module	13434	22441
3 row 36 module	13435	23400
4 row 72 module	13437	44661

Mini Enclosure (suitable to mount modular devices and PratiKa 16A socket)



Description	Reference	Unit MRP [₹]
4 module 1 vertical opening	13175 <input checked="" type="checkbox"/>	2378
4 module 2 horizontal opening	13176	2933
4 module 3 horizontal opening	13177	3692

Note: For all above Reference MOQ = 1

Please contact Customer Care Center for Stockable and Non stockable status of references.

NORMAL STOCK ITEMS

W.E.F. April 01st, 2026

Enclosure (suitable to mount modular devices and PratiKa 16A / 32A sockets)



Description	Reference	Unit MRP [₹]
5 module 2 opening	13178 <input checked="" type="checkbox"/>	5722
8 module 4 horizontal opening	13179	7811
13 module 3 opening	13180	10321
13 module 6 opening	13181	11346
19 module 8 opening	13182	14622

Functional Plaques



Description	Reference	Unit MRP [₹]
Blank - marked for 1 socket 50x50	13135	740
Blank - marked for 1 socket 65x65 or 75x75	13137	740
Intermediate with 65x85 opening	13136	902
Intermediate with one opening for 65x85 & 90x100	13142	1497

Note: For all above Reference MOQ = 1

Please contact Customer Care Center for Stockable and Non stockable status of references.

NORMAL STOCK ITEMS

W.E.F. April 01st, 2026

Wander Plugs



PKE16M423



PKE16M723



81383

- Conforms to IEC 60309-1 & IEC 60309-2
- PK PratiKa Screw Connect: same orientation of clamp's screws
- External impact strength: IK08
- Glow wire test: 850°C

[In] Rated Current (A)	[Ue] Rated Operational Voltage (V)	Poles Description	Reference	Unit MRP [₹]
PratiKa Screw				
IP44				
16	200...250	2P + E	PKE16M423 <input checked="" type="checkbox"/>	725
		2P + E	PKX16M423 <input type="checkbox"/>	1480
	380...415	3P + E	PKE16M434 <input checked="" type="checkbox"/>	927
		3P + N + E	PKE16M435 <input checked="" type="checkbox"/>	966
32	200...250	2P + E	PKE32M423 <input checked="" type="checkbox"/>	1141
	380...415	3P + E	PKE32M434 <input checked="" type="checkbox"/>	1338
		3P + N + E	PKE32M435 <input checked="" type="checkbox"/>	1306
IP67				
16	200...250	2P + E	PKE16M723 <input checked="" type="checkbox"/>	1585
	380...415	2P + E	PKX16M723 <input type="checkbox"/>	2355
		3P + E	PKE16M734 <input checked="" type="checkbox"/>	1807
32	380...415	3P + N + E	PKE16M735 <input checked="" type="checkbox"/>	1931
		2P + E	PKE32M723 <input checked="" type="checkbox"/>	2264
	200...250	3P + E	PKE32M734 <input checked="" type="checkbox"/>	2442
		3P + N + E	PKE32M735 <input checked="" type="checkbox"/>	2437
PK (63A & 125A available in IP67 only)				
63	200...250	2P + E	81378	6418
	380...415	3P + E	81382 <input checked="" type="checkbox"/>	6117
125	380...415	3P + N + E	81383 <input checked="" type="checkbox"/>	6069
		3P + E	81394	18715
		3P + N + E	81395	18715

Note: * Fast Connection

Small Wall Mounted Sockets



PKF16W423



PKF16W723



PKF32W735

- Conforms to IEC 60309-1 & IEC 60309-2
- External impact strength: IK08
- Glow wire test: 850°C

[In] Rated Current (A)	[Ue] Rated Operational Voltage (V)	Poles Description	Reference	Unit MRP [₹]
IP44				
16	200...250	2P + E	PKF16W423	1282
	380...415	3P + E	PKF16W434	1487
		3P + N + E	PKF16W435	1624
32	200...250	2P + E	PKF32W423	1676
	380...415	3P + E	PKF32W434	2011
		3P + N + E	PKF32W435	2124
IP67				
16	200...250	2P + E	PKF16W723	2036
	380...415	3P + E	PKF16W734	2558
		3P + N + E	PKF16W735	2645
32	200...250	2P + E	PKF32W723	2549
	380...415	3P + E	PKF32W734	3721
		3P + N + E	PKF32W735	4936

Note: For all above Reference MOQ = 1

Please contact Customer Care Center for Stockable and Non stockable status of references.

*Bold references are MTO reference.

Wall Mounted Sockets



- Conforms to IEC 60309-1 & IEC 60309-2
- Rated operational voltage upto 415V
- Rated operational current upto 125A
- External impact strength: IK08
- Glow wire test: 850°C
- Available only in IP67

[In] Rated Current (A)	[Ue] Rated Operational Voltage (V)	Poles Description	Reference	Unit MRP [₹]
63	200...250	2P + E	81178	7905
		3P + E	81182 ●	8709
	380...415	3P + N + E	81183	8254
125	380...415	3P + E	81194	28512
		3P + N + E	81195	28651

Wander Sockets



- PK PratiKa Screw Connect: same orientation of clamp's screws.
- PK PratiKa: 16A & 32A; IP44 & IP67
- External impact strength: IK08
- Glow wire test: 850 °C
- Conforms to IEC 60309-1 & IEC 60309-2

[In] Rated Current (A)	[Ue] Rated Operational Voltage (V)	Poles Description	Reference	Unit MRP [₹]
PratiKa Screw				
IP44				
16	200...250	2P + E	PKF16M423 ✓	1014
		2P + E	PKY16M423	1117
	380...415	3P + E	PKF16M434	1170
		3P + N + E	PKF16M435	1277
32	200...250	2P + E	PKF32M423 ✓	1394
		3P + E	PKF32M434	1693
	380...415	3P + N + E	PKF32M435 ✓	1703
		IP67		
16	200...250	2P + E	PKF16M723	1878
		2P + E	PKY16M723 ●	2284
	380...415	3P + E	PKF16M734	2355
		3P + N + E	PKF16M735	2460
32	380...415	2P + E	PKF32M723	2582
		3P + E	PKF32M734	2857
	3P + N + E	PKF32M735	2884	
PK (63A & 125A available in IP67 only)				
63	200...250	2P + E	81478	6990
	380...415	3P + E	81482	7051
		3P + N + E	81483	7097
125	380...415	3P + E	81494	22066
		3P + N + E	81495	22498

Also Available on Request:

- Patented FAST connect Plugs & Sockets - innovative cabling system that enables connection without stripping the conductor and with absolutely no screws required
 - Extra Low Voltage Plugs & Sockets down to 50V
- Please contact nearest Schneider Electric Sales Office or Customer Care for Reference and Prices

Note: For all above Reference MOQ = 1

Please contact Customer Care Center for Stockable and Non stockable status of references.
*Bold references are MTO reference.

Panel Mounted Sockets - Angled



- PK PratiKa Screw Connect: same orientation of clamp's screws
- External impact strength: IK08
- Glow wire test: 850°C
- Conforms to IEC 60309-1 & IEC309-2

[In] Rated Current (A)	[Ue] Rated Operational Voltage (V)	Poles Description	Reference	Unit MRP [₹]
PratiKa Screw				
IP44				
16	200...250	2P + E	PKF16F423 <input checked="" type="checkbox"/>	831
		2P + E	PKY16F423 ●	846
	380...415	3P + E	PKF16F434	1170
		3P + N + E	PKF16F435 <input checked="" type="checkbox"/>	1248
32	200...250	2P + E	PKF32F423 <input checked="" type="checkbox"/>	1380
	380...415	3P + E	PKF32F434	1618
		3P + N + E	PKF32F435	1595
IP67				
16	200...250	2P + E	PKF16F723 <input checked="" type="checkbox"/>	1464
	380...415	2P + E	PKY16F723 ●	1790
		3P + E	PKF16F734	1683
32	200...250	3P + N + E	PKF16F735 <input checked="" type="checkbox"/>	1703
	380...415	2P + E	PKF32F723	1924
		3P + E	PKF32F734	2248
		3P + N + E	PKF32F735	2263
PK (63A & 125A available in IP67 only)				
63	200...250	2P + E	81278	6311
	380...415	3P + E	81282 <input checked="" type="checkbox"/>	6322
125		380...415	3P + N + E	81283 <input checked="" type="checkbox"/>
	3P + E		81294	21292
			3P + N + E	81295

Panel Mounted Sockets - Straight



- PK PratiKa Screw Connect: same orientation of clamp's screws
- External impact strength: IK08
- Glow wire test: 850°C
- Conforms to IEC 60309-1 & IEC309-2

[In] Rated Current (A)	[Ue] Rated Operational Voltage (V)	Poles Description	Reference	Unit MRP [₹]
PratiKa Screw				
IP44				
16	200...250	2P + E	PKF16G423	889
		2P + E	PKY16G423	1317
	380...415	3P + E	PKF16G434	1549
		3P + N + E	PKF16G435	1338
32	200...250	2P + E	PKF32G423	1410
	380...415	3P + E	PKF32G434	1624
		3P + N + E	PKF32G435	1760
IP67				
16	200...250	2P + E	PKF16G723	1487
	380...415	2P + E	PKY16G723 ●	1676
		3P + E	PKF16G734	2046
32	380...415	3P + N + E	PKF16G735	1703
		2P + E	PKF32G723	1897
	200...250	3P + E	PKF32G734	2134
		3P + N + E	PKF32G735	2214
PK (63A & 125A available in IP67 only)				
63	380...415	3P + E	81682	6384
125		3P + N + E	81683	6384
		3P + N + E	81695	21395

*Fast Connection

Note: For all above Reference MOQ = 1

Please contact Customer Care Center for Stockable and Non stockable status of references.

*Bold references are MTO reference.

Sockets with Interlock Switches - for guaranteed safety of operation

- Allows closure of main switch only when the plug is fully inserted in socket - when complete mechanical & electrical connection has occurred
- Plug removal is possible only when the switch is in "off" position

Wall Mounted Sockets with Interlock Switch Unika (w/o protection)



83047

83081

- Switch designed for use in AC 22A class applications
- Conforms to IEC 60309-1 & IEC 60309-2
- Rated operational voltage upto 415V
- Rated operational current upto 32A
- External impact strength: IK08
- Available in IP44 / IP65 versions
- Glow wire test: 750°C

[In] Rated Current (A)	[Ue] Rated Operational Voltage (V)	Poles Description	Reference	Unit MRP [₹]
IP44				
16	200...250	2P + E	83031	10668
	380...415	3P + N + E	83036	15057
32	200...250	2P + E	83042 <input checked="" type="checkbox"/>	13717
	380...415	3P + E	83046	22417
		3P + N + E	83047	16164
IP65				
16	200...250	2P + E	83081	11037
	380...415	3P + E	83085	15200
		3P + N + E	83086	15509
32	200...250	2P + E	83092	14465
	380...415	3P + N + E	83097	17368

Socket with Interlock Switch & DIN Rail Isoblock (4.5 modules)



82754

83796

- Switch designed for use in AC- 22A class applications
- Conforms to IEC 60309-1 & IEC 60309-2
- Provision to DIN mount 4.5 module device
- External impact strength: IK10
- Available in IP65 version
- Glow wire test: 850°C

[In] Rated Current (A)	[Ue] Rated Operational Voltage (V)	Poles Description	Reference	Unit MRP [₹]
16	200...250	2P + E	82754 <input checked="" type="checkbox"/>	13099
	380...415	3P + N + E	82759	20223
32	200...250	2P + E	83791 <input checked="" type="checkbox"/>	15509
	380...415	3P + E	83795	22516
		3P + N + E	83796	18476

Socket with Interlock Switch & DIN Rail Isoblock (6 modules)



82766

- Switch designed for use in AC-22A class applications
- Conforms to IEC 60309-1 & IEC 60309-2
- Provision to DIN mount 6 module device
- External impact strength: IK10
- Available in IP65 version
- Glow wire test: 850°C

[In] Rated Current (A)	[Ue] Rated Operational Voltage (V)	Poles Description	Reference	Unit MRP [₹]
32	200...250	2P + E	82766	20655
63	380...415	3P + E	82782	27832
		3P + N + E	82783	27654

Please contact Customer Care Center for Stockable and Non stockable status of references.

*Bold references are MTO reference.

ELECTRA Metal Clad Plugs & Sockets are specially designed incorporating the latest safety, quality and user friendly features.

Construction

- The casting is made from non-corroding die-cast aluminum alloy combining exceptional compactness with high strength
- The design/construction eliminates the possibility of mismatch in fitting of plugs in corresponding sockets
- The floating contacts in the sockets are self aligning and facilitates smooth plugging in without undue pressure (These can be easily removed for wiring)
- A provision for pilot pin facilitates mechanical interlocking in case of 63A ratings

Human Safety

Specially designed shroud to avoid accidental finger contact with plug-pins while inserting/removing the plug
Similarly, the contact tubes in sockets are deeply recessed to avoid human contact

- The earthing pins ensure that earth connection is made first and broken last, being longer than conducting pins
- The visible earth terminals facilitate easy checking of earth connection
- The cable grip to the plug is made very strong by providing a compression gland and by protecting it at the point of entry by a strong rubber guard

Applications

Industrial, Commercial & Domestic portable equipments like Hand/Power Tools, Industrial Ovens, Welding Sets, Mobile Generators, Furnaces, Ships, Office Machines, Refrigerators, Coolers, Air-Conditioners, Overhead Cranes, Chilling Cabinets, Tile Polishers and Sewing Machines

Plug



Rating (A)	Poles Description	Voltage (V)	MOQ	Reference	Unit MRP [₹]
10	2P	250	30	AP10 <input checked="" type="checkbox"/>	338
20	2P	250	30	AP20 <input checked="" type="checkbox"/>	356
20	3P	440	30	BP20 <input checked="" type="checkbox"/>	474
30	3P	440	20	BP30 <input checked="" type="checkbox"/>	862
63	3P+N+E	440	4	CP63 <input checked="" type="checkbox"/>	3899

Socket



Rating (A)	Poles Description	Voltage (V)	MOQ	Reference	Unit MRP [₹]
10	2P	250	30	AS10 <input checked="" type="checkbox"/>	356
20	2P	250	30	AS20 <input checked="" type="checkbox"/>	380
20	3P	440	30	BS20 <input checked="" type="checkbox"/>	532
30	3P	440	20	BS30 <input checked="" type="checkbox"/>	913
63	3P+N+E	440	4	CS63 <input checked="" type="checkbox"/>	4368

Please contact Customer Care Center for Stockable and Non stockable status of references.
*Bold references are MTO reference.

Complete range of switches & sockets suitable for both indoor & outdoor applications like Kitchens, Swimming Pools, Landscape Gardens, Exterior Walls and Other Environmentally Challenged Locations.



56SW116LE-GY



56SW216LE-GY



56SW332LE-GY

Description	IP Rating	Reference	Unit MRP [₹]
Surface Switches			
Single Pole Switches Less Enclosure			
1 Pole 250V 10A	IP66	56SW110LE-GY	4798
1 Pole 250V 16A	IP66	56SW116LE-GY	4452
1 Pole 250V 20A	IP66	56SW120LE-GY	6741
1 Pole 250V 32A	IP66	56SW132LE-GY	8039
Double Pole Switches Less Enclosure			
2 Pole 500V 16A	IP66	56SW216LE-GY	7766
2 Pole 500V 20A	IP66	56SW220LE-GY	7766
2 Pole 500V 32A	IP66	56SW232LE-GY	10306
2 Pole 500V 50A	IP66	56SW250LE-GY	12036
Triple Pole Switches Less Enclosure			
3 Pole 500V 10A	IP66	56SW310LE-GY	7183
3 Pole 500V 16A	IP66	56SW316LE-GY	7493
3 Pole 500V 20A	IP66	56SW320LE-GY	7888
3 Pole 500V 32A	IP66	56SW332LE-GY	9111
3 Pole 500V 50A	IP66	56SW350LE-GY	10612
3 Pole 500V 63A	IP66	56SW363LE-GY	12318
Four Pole Switches Less Enclosure			
4 Pole 500V 20A	IP66	56SW420LE-GY	11450



66CV563-RG



66P563-EO

Description	IP Rating	Reference	Unit MRP [₹]
IP66 Industrial Combination Switch Sockets with Enclosure			
Single Pole Switches Less Enclosure			
500V, 63A with 4 pole switch and 63A 5 Pin Socket	IP66	66CV563-RG	139606
Plug Top 5 Pin 500V 63A	IP66	66P563-EO	41903

Please contact Customer Care Center for Stockable and Non stockable status of references.

*Bold references are MTO reference.



56SO316RP-LE-GY-EX



56SO432LE-GY



56SO532LE-GY

Description	IP Rating	Reference	Unit MRP [₹]
Surface Socket Outlets			
3 Pin Sockets Less Enclosure			
3 Pin 250V 16A Indian Standard	IP66	56SO316RP-LE-GY-EX	4482
3 Pin 250V 20A Round Pin	IP66	56SO320LE-GY	6505
3 Pin 250V 32A Round Pin	IP66	56SO332LE-GY	7246
4 Pin Sockets Less Enclosure			
4 Pin 500V 20A Round Pin	IP66	56SO420LE-GY	9718
4 Pin 500V 32A Round Pin	IP66	56SO432LE-GY	11619
4 Pin 500V 50A Round Pin	IP66	56SO450LE-GY	17878
5 Pin Sockets Less Enclosure			
5 Pin 500V 10A Round Pin	IP66	56SO510LE-GY	10500
5 Pin 500V 20A Round Pin	IP66	56SO520LE-GY	10401
5 Pin 500V 32A Round Pin	IP66	56SO532LE-GY	12351
5 Pin 500V 40A Round Pin	IP66	56SO540LE-GY	17992
5 Pin 500V 50A Round Pin	IP66	56SO550LE-GY	18471

*Alternate reference 56SO440-GY (coming soon)



56PA420-EO



56PA532-EO



56CVI520-GY

Description	IP Rating	Reference	Unit MRP [₹]
Plugs			
3 Pin Angle Plugs			
3 pin 250V 16A Round Pin	IP66	56PA316RP-GY-EX	3371
3 Pin 250V 20A Round Pin	IP66	56PA320-EO	6741
3 Pin 250V 32A Round Pin	IP66	56PA332-EO	7788
4 Pin Angle Plugs			
4 Pin 500V 20A Round Pin	IP66	56PA420-EO	8294
4 Pin 500V 32A Round Pin	IP66	56PA432-EO	8634
4 Pin 500V 40A Round Pin	IP66	56PA440-EO	14360
4 Pin 500V 50A Round Pin	IP66	56PA450-EO	10245
5 Pin Angle Plugs			
5 Pin 500V 10A Round Pin	IP66	56PA510-EO	8152
5 Pin 500V 20A Round Pin	IP66	56PA520-EO	8152
5 Pin 500V 32A Round Pin	IP66	56PA532-EO	9329
5 Pin 500V 40A Round Pin	IP66	56PA540-EO	9961
5 Pin 500V 50A Round Pin	IP66	56PA550-EO	10198
Combination Switch Socket Outlet			
IP66 Interlocked Switch Socket with Enclosure			
4 Pin 500V 20A Round Pin	IP66	56CVI420-GY	35635
5 Pin 500V 20A Round Pin	IP66	56CVI520-GY	32239
5 Pin 500V 32A Round Pin	IP66	56CVI532-GY	32533

Please contact Customer Care Center for Stockable and Non stockable status of references.

*Bold references are MTO reference.

56 Series

Description	Module Width	Reference	Unit MRP [₹]
Switchgear Cover Assembly			
For 1,2,3 Pole MCB with 4 Pole RCD (max. 4M Width)	4	56CB4N-GY	7388



Description	No. of Gangs	Reference	Unit MRP [₹]
Flush Surrounds			
Flush Surround	2	56FA2-GY	3640
Flush Surround	3	56FA3-GY	5731
Mounting Enclosures (Back Boxes)			
101X101X63mm	1	56E1-GY	1568
198X101X63mm	2	56E2-GY	4023

Please contact Customer Care Center for Stockable and Non stockable status of references.
 *Bold references are MTO reference.

W.E.F. April 01st, 2026

SWITCH TO STYLE



Perfect solutions for the perfect you



LIVIA
Life. Style.



Miluz Lara



Opale



Unica Pure



ZENcelo



Avatar On



- **Sleek Design** - 2.7mm thin plate with curved body to minimize dust accumulation
- **Stylish Looks** - Soft white texture with glossy finish
- **Robust & Strong** - Innovative honeycomb designed grid plate for extra rigidity
- **Reliable** - High grade heat-resistant polycarbonate and laser marked wiring diagrams.
- **Easy to Install** - Snap-In / Snap-Out front loading modules and Bigger terminal holes
- **Green & Eco Friendly** - RoHS compliant range



Description	Reference for White	Unit MRP [₹]	Reference for Pristine Grey	Unit MRP [₹]
Switches				
10AX 1 way switch	P1001_N	162	P1001_PG_N	228
10AX 1 way switch with Indicator lamp	P1081	341	P1081_PG_N	451
10AX 2 way switch	P1002_N	266	P1002_PG_N	340
16AX 1 way switch	P1101_N	290	P1101_PG_N	355
16AX 1 way switch with Indicator lamp	P1181_N	403	P1181_PG_N	479
16AX 1 way switch (2M)	P1121_N	443	P1121_PG_N	581
16AX 2 way switch	P1102_N	397	P1102_PG_N	516
20A 1 way switch (1M) with indicator lamp	P11201_N	373	P11201_PG_N	427
20A DP switch with Indicator lamp	P1120_N	674	P1120_PG_N	878
32A DP switch with Indicator lamp	P1132_N	972	P1132_PG_N	1199
Bell Push				
10A Bell Push switch	P1005_N	297	P1005_PG_N	383
10A Bell Push switch (2M)	P1025_N	436	P1025_PG_N	518
10A bell push switch with Indicator	P1085_N	364	P1085_PG_N	483
10A bell push switch with Indicator (2M)	P1086_N	475	P1086_PG_N	603
Sockets				
6A 3Pin socket Outlet with shutter (BIS)	P2005NS_N	309	P2005NS_PG_N	380
10A/16A 3-pin Socket Outlet with Shutter	P2106_N	464	P2106_PG_N	563
Fan Regulators & Dimmers				
Step type fan regulator (1M)	P3100_N	948	P3100_PG_N	1153
Step type fan regulator (2M)	P3200_N	1088	P3200_PG_N	1359
Dimmer 400W (1M)	P3004_N	1788	P3004_PG_N	2290
Dimmer 1000W (2M)	P3012	2619	P3012_PG_N	2871
USB Charger				
USB Charger	P7002_N	2340	P7002_PG_N	2720
Livia - A+C Type USB Charger (1M)	P7003_N	3523	P7003_PG_N	4241
Accessories				
RJ 11 Telephone outlet with shutter	P4011_N	268	P4011_PG_N	352
RJ 45 Cat 5e Data outlet with shutter	P4045_N	908	P4045_PG_N	1089
RJ 45 Cat6 Data outlet with shutter	P4046_N	1011	P4046_PG_N	1288
TV socket	P4500_N	255	P4500_PG_N	340
Blank off unit (1M)	P0001_N	70	P0001_PG_N	92
Foot Lamp with LED	P7001_N	1116	P7001_PG_N	1329
Cord Outlet	-	-	P4550_PG_N	371
LED Phase Indicator	P5001_N	444	-	-
Mini MCB				
10A Mini MCB	P8010_N	638	P8010_PG_N	749
16A Mini MCB	P8016_N	638	P8016_PG_N	749
20A Mini MCB	P8020_N	638	P8020_PG_N	749
25A Mini MCB	P8025_N	638	P8025_PG_N	749
32A Mini MCB	P8032_N	638	P8032_PG_N	749

* Available till stocks lasts

Please contact Customer Care Center for Stockable and Non stockable status of references.

*Bold references are MTO reference.



P1186MS_N



P6002_N



P6004_N

Description	Reference for White	Unit MRP [₹]	Reference for Pristine Grey	Unit MRP [₹]
Motor Starter Switch				
25A Motor Starter switch	P1186MS_N	1656	P1186MS_PG_N	2080
Hotel Series				
DND Switch	P6002_N	378	P6002_PG_N	409
MMR Switch	P6004_N	347	P6004_PG_N	409
DND & MMR Indicator	P6013	1106	P6013_PG_N	1321
20A Key Card Switch - Electronic (3M)	P6005_N	5966	P6005_PG_N	7811



P0703_N



P0704_N



P0706_PG_N

Description	Reference for White	Unit MRP [₹]	Reference for Pristine Grey	Unit MRP [₹]
Cover Plates				
1-2 M Grid & 1 M Cover Frame	P0701_N	182	P0701_PG_N	216
1-2 M Grid & 2 M Cover Frame	P0702_N	182	P0702_PG_N	219
3 M Grid & 3 M Cover Frame	P0703_N	229	P0703_PG_N	257
4 M Grid & 4 M Cover Frame	P0704_N	265	P0704_PG_N	319
6 M Grid & 6 M Cover Frame	P0706_N	340	P0706_PG_N	418
8 M Grid & 8 M Cover Frame - Horizontal	P0708_N	446	P0708_PG_N	525
8 M Grid & 8 M Cover Frame - Square	P0709_N	538	P0709_PG_N	637
9 M Grid & 9M Cover Frame	P07010_N	508	P07010_PG_N	901
12 M Grid & 12 M Cover Frame	P0712_N	633	P0712_PG_N	785
16 M Grid & 16M Cover Frame	P07016_N	768	P07016_PG_N	1228
18 M Grid & 18 M Cover Frame	P0718_N	956	P0718_PG_N	1113

Please contact Customer Care Center for Stockable and Non stockable status of references.
*Bold references are MTO reference.

W.E.F. April 01st, 2026



A fusion of beauty and functionality:

- Dew-drop-inspired design prevents dust and dirt accumulation.
- The 'volcanic' curve ensures ample room for wiring, for a seamless user experience.

Ideal for Mivan and modern construction methods:

- Seamlessly fits into newer (40 mm.) and conventional (50 mm.) metal boxes.

Durability and Safety:

- Prevents accidental shocks with no single-pin insertion in sockets.
- Durable copper contact for an enhanced life span (lasts up to 2 lakh clicks, or 30 years, at 15 clicks/day)

Effortless Installation:

- Clear markings for ideal wire strip length for accurate and safe installation
- Front-loading components and double-sided wire entry in sockets for greater ease.

Seamless Connectivity:

- Wiser™ is designed to optimize energy usage and is fully compatible with Miluz Lara switches and sockets.

Now Miluz Lara comes with the 10 years of warranty

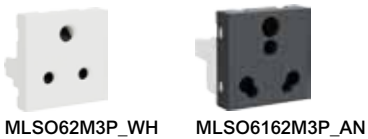
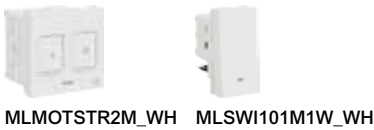

Description	Reference for White	Unit MRP [₹]	Pack	Reference for Anthracite	Unit MRP [₹]	Pack
Switches						
10 A 1-way Switch (1M)	MLSW101M1W_WH	141	20	MLSW101M1W_AN	162	20
10 A 1-way Switch with Indicator (1M)	MLSWI101M1W_WH	370	20	MLSWI101M1W_AN	401	20
10 A 1-way Switch (2M)	MLSW102M1W_WH	385	10	MLSW102M1W_AN	435	10
10 A 1-way Switch with Indicator (2M)	MLSWI102M1W_WH	443	10	MLSWI102M1W_AN	442	10
10 A 2-way Switch (1M)	MLSW101M2W_WH	278	20	MLSW101M2W_AN	320	20
16 A 1-way Switch (1M)	MLSW161M1W_WH	298	20	MLSW161M1W_AN	343	20
16 A 1-way Switch with Indicator (1M)	MLSWI161M1W_WH	420	20	MLSWI161M1W_AN	483	20
16 A 1-way Switch (2M)	MLSW162M1W_WH	512	10	MLSW162M1W_AN	589	10
16 A 1-way Switch with Indicator (2M)	MLSWI162M1W_WH	552	10	MLSWI162M1W_AN	636	10
16 A 2-way Switch (1M)	MLSW161M2W_WH	450	20	MLSW161M2W_AN	530	20
20 A DP Switch with Indicator (2M)	MLSWI202MDP_WH	904	10	MLSWI202MDP_AN	963	10
32 A DP Switch with Indicator (2M)	MLSWI322MDP_WH	1218	10	MLSWI322MDP_AN	1282	10
Motor Starter Switch						
25 A Motor Starter Switch (2M)	MLMOTSTR2M_WH	2409	10	MLMOTSTR2M_AN	2586	10
Bell Push Switch						
6 A Bell Push (1M)	MLBP1M_WH	372	20	MLBP1M_AN	453	20
6 A Bell Push with Indicator (1M)	MLBPI1M_WH	416	20	MLBPI1M_AN	497	20
6 A Bell Push (2M)	MLBP2M_WH	437	10	MLBP2M_AN	580	10
6 A Bell Push with Indicator (2M)	MLBPI2M_WH	522	10	MLBPI2M_AN	631	10
Sockets						
6 A 3 Pin Socket with Shutter (2M)	MLSO62M3P_WH	276	10	MLSO62M3P_AN	318	10
6 A/16 A 3P Socket with Shutter (2M)	MLSO6162M3P_WH	442	10	MLSO6162M3P_AN	508	10
Fan Regulators and Dimmers						
4-Step Fan Regulator (1M)	MLFR4STP1M_WH	962	20	MLFR4STP1M_AN	1107	20
5-Step Fan Regulator (2M)	MLFR5STP2M_WH	1215	10	MLFR5STP2M_AN	1398	10
400 W Dimmer (1M)	MLDMR1M_WH*	1691	10	MLDMR1M_AN*	1946	10
USB Charger						
2.1 A USB Charger (1M)	MLUSBA1M_WH	2222	10	MLUSBA1M_AN	2432	10
1M 12 W Type A+C USB Charger (1M)	MLUSBAC1M_WH	3317	20	MLUSBAC1M_AN	3814	20
USB A+C 21W PD Horizontal	MLUSBAC2MPDH_WH	4567	10	MLUSBAC2MPDH_AN	5479	10
Air Quality Indicator						
Air Quality Indicator (2M)	MLAQI2M_WH*	22096	-	MLAQI2M_AN*	22591	-
Voltage Surge Protector						
Voltage Surge Protector 230 V (1M)	MLVSP1M_WH	2917	10	MLVSP1M_AN	3354	10

*Prices will be shared on request

Please contact Customer Care Center for Stockable and Non stockable status of references.

*Bold references are MTO reference.



Description	Reference for White	Unit MRP [₹]	Pack	Reference for Anthracite	Unit MRP [₹]	Pack
Accessories						
TV Socket (1M)	MLTV1M_WH	263	10	MLTV1M_AN	342	10
RJ11 Tel. Outlet with Shutter (1M)	MLRJ111M_WH	274	10	MLRJ111M_AN	359	10
RJ45 Cat. 6 Data Outlet Shuttered (1M)	MLRJ451M_WH	994	10	MLRJ451M_AN	1216	10
Preterminated HDMI socket (1M)	MLHDMI1M_WH	1658	10	MLHDMI1M_AN	1907	10
LED Footlamp (2M)	MLFTLMP2M_WH	1050	10	MLFTLMP2M_AN	1161	10
Door Chime (2M)	MLDRCHM2M_WH*	1326	-	MLDRCHM2M_AN*	1525	-
Blank Off Unit (1M)	MLBLANK1M_WH	68	20	MLBLANK1M_AN	88	20
Socket Adaptor (2M)	MLSA2M_NC	155	10	-	-	-
LED Phase Indicator (Red) (1M)	MLPHSIND1M_RD	442	10	-	-	-
MCB						
16A MCB SP 1M C curve	MLMM161P_WH	885	10	MLMM161P_AN	940	10
20A MCB SP 1M C curve	MLMM201P_WH	885	10	MLMM201P_AN	940	10
32A MCB SP 1M C curve	MLMM321P_WH	885	10	MLMM321P_AN	940	10
Hospitality						
Curtain Control Switch	MLCCSW2M_WH	957	10	MLCCSW2M_AN	1099	10
DND MMR Switch	MLDMSW2M_WH	940	10	MLDMSW2M_AN	1077	10
DND MMR Indicator, ANTHRACITE	MLDMI1M_NA	719	10	-	-	-
Electronic Keycard Switch	MLKECRDSW2M_WH	4974	10	MLKECRDSW2M_AN	5528	10
115V Shaver Socket Horizontal	MLSHVRSO3M_WH	4422	10	MLSHVRSO3M_AN	4974	10
USB A+C 21W PD Horizontal	MLUSBAC2MPDH_WH	4567	-	MLUSBAC2MPDH_AN	5479	-
6A Switched Socket 2M	MLSWSO62M_WH	483	-	MLSWSO62M_AN	579	-
Cover Plates						
1M or 2M Grid and 1M Cover Frame	MLCP1M_WH	193	15	MLCP1M_AN	250	15
1M or 2M Grid and 2M Cover Frame	MLCP2M_WH	193	15	MLCP2M_AN	250	15
3M Grid and 3M Cover Frame	MLCP3M_WH	247	10	MLCP3M_AN	322	10
3M Uni Grid and 3M Cover Frame	MLCP3MU_WH	270	10	MLCP3MU_AN	351	10
4M Grid and 4M Cover Frame	MLCP4M_WH	285	8	MLCP4M_AN	370	8
6M Grid and 6M Cover Frame	MLCP6M_WH	359	5	MLCP6M_AN	466	5
8M Grid and 8M Cover Frame, Horizontal	MLCP8MH_WH	473	5	MLCP8MH_AN	615	5
8M Grid and 8M Cover Frame, Square	MLCP8MS_WH	621	5	MLCP8MS_AN	808	5
9M Cover Frame + 8M Grid	MLCP9M_WH	584	5	MLCP9M_AN	759	5
12M Grid and 12M Cover Frame	MLCP12M_WH	752	5	MLCP12M_AN	978	5
16M Cover Frame and Grid	MLCP16M_WH	895	5	MLCP16M_AN	1164	5
18M Grid and 18M Cover Frame	MLCP18M_WH	1082	5	MLCP18M_AN	1407	5

Please contact Customer Care Center for Stockable and Non stockable status of references.
*Bold references are MTO reference.

Wiring Diagram Miluz Lara

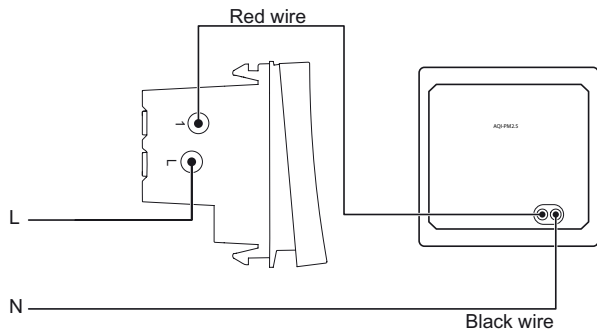

> Air Quality Indicator
MLAQI2M_WH, MLAQI2M_AN

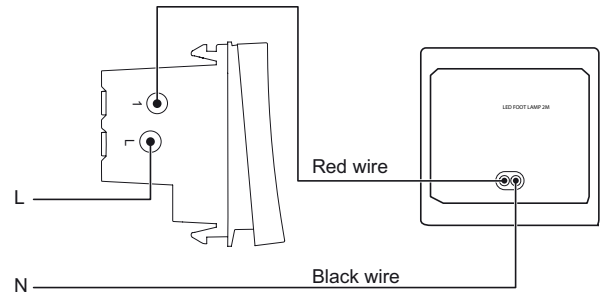

> LED Footlamp
MLFTLMP2M_WH, MLFTLMP2M_AN

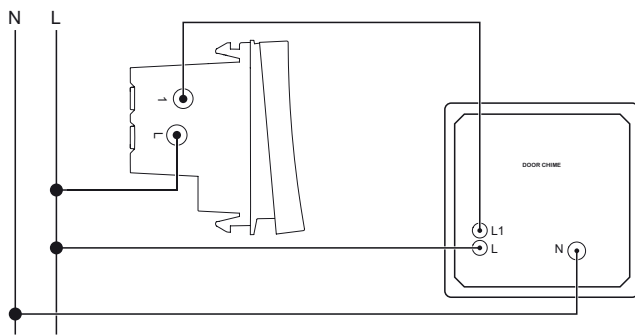

> Door Chime
MLDRCHM2M_WH, MLDRCHM2M_AN

12 W Type A+C USB Charger

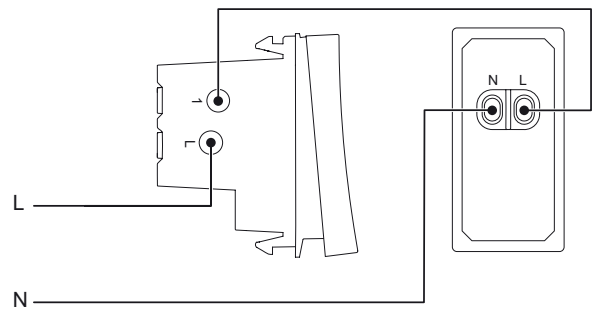

> USB Chargers
MLUSBAC1M_WH, MLUSBAC1M_AN

10 Years Warranty T&C

- Schneider Electric shall, at its sole discretion, repair or replace switches upto 16A (without LED indicator/lamp) and or 6A & 16A sockets in white color only if the Product is found to be having manufacturing defect (means defects solely as a result of faulty material and/or workmanship during manufacturing of Product) within 10 years from the date of manufacture of Product or from the date of invoice of Product, whichever is earlier.
- For all other wiring accessories, the warranty shall be 18 months starting from the date of delivery or 24 months from the date of manufacturing, whichever is earlier
- The warranty defines Schneider Electric's overall sole liability which does not include any other liability whatsoever including without limitation consequential losses or damages or re-installation costs arising from or in relation to the defective products.
- Schneider Electric reserves the right to change and/or improve the design of its Products without prior notice
- In any event whatsoever, if same Product with a similar design is not available, the Product will be replaced with an equivalent model available at that time at sole discretion of Schneider Electric.
- ***This warranty for the above products shall be rendered null & void in case of the following:***
 - a. If the original Schneider Electric mounting boxes have not been used to mount the plates & accessories.
 - b. If any attempt has been made to rectify, dismantle, tamper, or alter the product by any third party or by the customer himself.
 - c. If any damage resulting from the use of any cleaning chemicals on the Product which can adversely affect the product material (Like Acetone, Thinner, turpentine Oil etc.)
 - d. If the products are not installed as per the appropriate design specifications
- Warranty facilitations as per the standard process where customer to contact Customer Care Center (Email, Toll Free, chat) with relevant details & Log the complaint.

Opale - Switches with Satin Finish



- **Patented Smooth Satin Finish** - Scratch Resistant, Easy to Clean & Prevents light reflection off surface
- **Safe to Use** - High grade flame retardant polycarbonate material & Child Proof sockets with unique shutter design
- **Hassle Free Operation** - 'Soft sound' switches with Gold plated Data Socket contacts for better connection
- **Easy to Install** - Snap-In / Snap-Out front loading modules and terminals with indented screws
- **Green & Eco Friendly** - RoHS compliant range



X1001WH



X1286WH



X1186WH



X1005WH



X1085WH



X2005WHNS



X2106WH



X3200WHCM



X3104WH



X7003WH



X5001

Description	Reference for White	Unit MRP [₹]	Pack	Reference for Coke Grey	Unit MRP [₹]	Pack
Switches						
6AX 1 way switch	X1001WH	293	20	AAKY1001	371	20
6AX 1 way switch with Indicator lamp	X1081WH	549	20	-	-	-
6AX 2 way switch	X1002WH	410	20	-	-	-
16AX 1 way switch	X1101WH	469	20	AAKY1101	593	20
16AX 1 way switch with Indicator lamp	X1181WH	671	20	AAKY1181	784	20
16AX 2 way switch	X1102WH	633	20	-	-	-
20A DP switch with Indicator (2M)	X1286WH	1109	10	-	-	-
32A DP switch (2M)	AAKX1232	1696	10	-	-	-
Motor Starter Switch						
25A Motor Starter switch	X1186WH	3195	10	-	-	-
Bell Push						
6A Bell Push	X1005WH	459	20	-	-	-
6A Bell Push (2M)	X1025WH	657	10	-	-	-
6A Bell Push with Indicator	X1085WH	916	20	-	-	-
Sockets						
6A 3-Pin Socket Outlet with Shutter (BIS)	X2005WHNS	500	10	AAKY2005NS	603	10
6A/16A 3-Pin Socket Outlet with Shutter	X2106WH	771	10	-	-	-
Fan Regulators & Dimmers						
Step Fan Regulator (1M)	X3100CMWH	1252	10	-	-	-
Step Type Fan Regulator (2M)	X3200WHCM	1806	5	-	-	-
Dimmer 400W (1M)	X3104WH	1673	10	-	-	-
Dimmer 400W (2M)	X3004WH	2603	5	-	-	-
USB Chargers						
2 Gang USB Charger - 2.1A (2M)	X7003WH	4942	15	-	-	-
Accessories						
RJ11 Telephone outlet with shutter	X4011WH	419	10	-	-	-
RJ45 Data Outlet with shutter	X4045WH	1443	20	-	-	-
TV Socket	X4500WH	392	10	-	-	-
RJ45 Cover for Key Stone Type	X4050WH	581	10	-	-	-
Buzzer	X3300WH	1876	2	-	-	-
Blank off unit (1M)	X0001WH	108	10	-	-	-
Neon Phase Indicator (Red)	X5001	665	20	-	-	-

Please contact Customer Care Center for Stockable and Non stockable status of references.
*Bold references are MTO reference.

W.E.F. April 01st, 2026

Opale - Switches with Satin Finish



AAKX6006



AAKX6005

Description	Reference	Unit MRP [₹]	Pack
Hotel Series*			
Key Tag Switch (Mechanical Type 20 A)	AAKX6005	2503	1
Shaver Socket	AAKX6006	11040	1

*Available in white colour only



X0703



X0704



X0708

Description	Reference for White	Unit MRP [₹]	Pack	Reference for Coke Grey	Unit MRP [₹]	Pack
Cover Plates						
1-2 M Grid & 1 M Cover Frame	X0701	266	10	AAKY0801	351	10
1-2 M Grid & 2 M Cover Frame	X0702	282	10	-	-	-
3 M Grid & 3 M Cover Frame	X0703	333	10	-	-	-
4 M Grid & 4 M Cover Frame	X0704	391	10	-	-	-
6 M Grid & 6 M Cover Frame	X0706	545	5	AAKY0806	652	5
8 M Grid & 8 M Cover Frame - Horizontal	X0708	708	5	-	-	-
8 M Grid & 8 M Cover Frame - Square	X0709	846	5	-	-	-
12 M Grid & 12 M Cover Frame	X0712	1004	5	-	-	-
18 M Grid & 18 M Cover Frame	AAKX0718	1309	5	-	-	-

Please contact Customer Care Center for Stockable and Non stockable status of references.

*Bold references are MTO reference.

W.E.F. April 01st, 2026

Unica Pure - Irresistibly Beautiful



Wood



Glass



Metal Rhodium Black



Sandy Beige



Polar White



Volcanic Grey



Pearl Black



Pewter Grey



Oak

Irresistibly Beautiful

- Authentic finishes - developed from the high quality natural material
- Ingenious Design - Demarcated dolly depicting clear on/off mode of the switch
- Modish Colors - perfectly gel with neutral, accent wall colors and blends perfectly with any decor

Irresistibly Safe & Sturdy

- Self Piercing Terminal - ensuring completely safe, robust and fast installation
- Facile & Guarded Technology - reduces tension in the switch rocker & increases the longevity of the switch
- Plated metal with Plastic over molded Gridplate - Robust, rigid & shock proof gridplate, ensuring durable installation on the metal box

Irresistibly Easy

- Key Hole Feature - Angular and linear adjustments of the gridplate can be easily achieved
- Revolutionary Ease of Mounting with Indicators & Markings

Irresistibly Sustainable

- Green Premium - Complies to HIGHEST INTERNATIONAL STANDARD of Green Certification for manufactured products (RoHS, REACH, PEP, EoLI) and is 100% Recyclable

Irresistibly Innovative

- Future Ready - Features of Voice & Mobile control to fit with smart homes

Irresistibly Versatile

- One Stop Shop - Extensive range covering residential, office, commercial or hospitality
- **Intermediate switches to control multiple 2way switches**

Unica Pure switches with six patented technologies



Life Guarded Sockets

Eliminate possibility of Single Pin Insertion making it extra safe for children

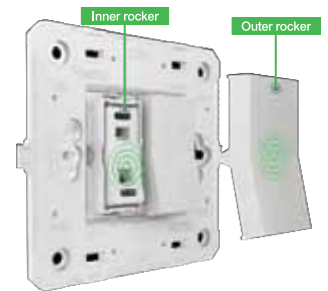

Facile & Guarded Technology

Reduces tension in the switch rocker & increases the longevity of the switch

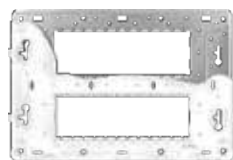

Key Hole Feature

Angular and linear adjustments of the gridplate can be easily achieved



Adjoining (V) Feature Technology

Ensuring perfect alignment of switches

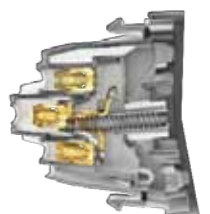

Self-piercing Terminal

Ensuring completely safe, robust and fast installation

Unica Pure - Irresistibly Beautiful

Description		Reference for Polar White	Unit MRP	Pack	Reference for Volcanic Grey	Unit MRP	Pack
6A Switches							
6AX 1 Way Switch		UNS61SW1M_WE	253	20	UNS61SW1M_GY	295	20
6AX 1 Way Switch With Indicator		UNS61SWL1M_WE	457	20	UNS61SWL1M_GY	524	20
6AX 2 Way Switch		UNS62SW1M_WE	367	10	UNS62SW1M_GY	411	10
10A Intermediate Switches							
10AX Intermediate Switch		UNS10SW1M_WE	1707	1	UNS10SW1M_GY	2059	1
16AX Switches							
16AX 1 Way Switch		UNS161SW1M_WE	422	20	UNS161SW1M_GY	492	20
16AX 1 Way Switch With Indicator		UNS161SWL1M_WE	505	20	UNS161SWL1M_GY	587	20
16AX 2 Way Switch, Polar White		UNS162SW1M_WE	566	10	UNS162SW1M_GY	666	10
16A Master Switch, 2 Way, With Locator & Label		UNS162MSWL1M_WE	1315	20	UNS162MSWL1M_GY	1554	1
16Ax 2 Way 2M Switch		UNS162SW2M_WE	575	10	UNS162SW2M_GY	683	10
16AX-20A 1Way switch with Neon indicator		UNS201SWL1M_WE	505	10	UNS201SWL1M_GY	597	10
Double Pole Switches							
20A Double Pole Switch With Indicator		UNS20DP2M_WE	1017	10	UNS20DP2M_GY	1198	1
32A Double Pole Switch With Indicator		UNS32DP2M_WE	1513	10	UNS32DP2M_GY	1812	10
Motor Starter Switch							
Motor Starter		UNSMTSTART2M_WE	2318	10	UNSMTSTART2M_GY	2741	10
Bell Switches							
6A Bellpress, 1M		UNS6BP1M_WE	372	20	UNS6BP1M_GY	436	20
6A Bellpress With Indicator, 1M		UNS6BPL1M_WE	514	20	UNS6BPL1M_GY	615	1
6A Bellpress, 2M, Polar White		UNS6BP2M_WE	516	10	UNS6BP2M_GY	607	1
6A Bellpress With Indicator, 2M		UNS6BPL2M_WE	637	10	UNS6BPL2M_GY	748	1
6A Sockets							
6A 3PIN Sockets outlet with Shutter (BIS)		UNS6SK3P2MNS_WE	532	10	UNS6SK3P2MNS_GY	590	10
6A Switched Socket 2M		UNSSWSO62M_WE	751	10	UNSSWSO62M_GY	827	10
6/16A Sockets							
6/16A Socket		UNS616SK2M_WE	628	10	UNS616SK2M_GY	780	10
USB Chargers							
2.1A 5V USB Charger, 2 Module		UNS21USB2P2M_WE	3916	10	UNS21USB2P2M_GY	4628	1
2.1A 5V USB Charger, 1 Module		UNS21USB1P1M_WE	2692	20	UNS21USB1P1M_GY	3193	20
2.4A 5V A+C USB Charger, 1 Module		UNSAUSB1P1M_WE	4146	10	UNSAUSB1P1M_GY	4662	10
USB A+C 21W PDH 2M WE		UNSSUSBAC2MPDH_WE	6262	10	UNSSUSBAC2MPDH_GY	6889	10
Blank Plates							
Single Module Blank Plate		UNSBLANK1M_WE	91	20	UNSBLANK1M_GY	102	20
Fan Regulators							
4 Steps 360 Deg Fan Regulator, 1M		UNS4STFAN1M_WE	1106	20	UNS4STFAN1M_GY	1281	20
5 Steps 360 Deg Fan Regulator, 2M		UNS5STFAN2M_WE	1768	10	UNS5STFAN2M_GY	1996	10
Emergency Light Indicator							
Emergency Light Module*		UNSEMERGENCY2M_WE	14513	1	-	-	-
Network, Connectivity & Media Series							
RJ 11 (WITH Shutter)		UNSRJ11_1M_WE	359	20	UNSRJ11_1M_GY	423	20
RJ 45 (WITH Shutter), Cat 6		UNSRJ45_1M_WE	1308	20	UNSRJ45_1M_GY	1515	20
TV Socket Coaxial		UNSTVCOAX1M_WE	377	20	UNSTVCOAX1M_GY	446	20
Volume Control		UNSVOLCTRL2M_WE	3050	10	UNSVOLCTRL2M_GY	3637	10
HDMI		UNSHDMI_WE	2626	20	UNSHDMI_GY	2962	20
TV Socket Digital (F-Connector)		UNSCPTVDIG1M_WE	427	1	-	-	-
PIR Motion Sensor*		UNSPIR_WE	12481	4	-	-	-

Please contact Customer Care Center for Stockable and Non stockable status of references.
*Bold references are MTO reference.

W.E.F. April 01st, 2026

Unica Pure - Irresistibly Beautiful



UNSEKCSW_WE



UNSSHAVER_WE



UNSSKTLT2M_WE



UNFLVPB1M1G_WE



UNSPHASEG1M



UNSCURTAINSW2M_WE



UNSPIR_WE



UNFLVPB1M2G_WE



UNSPHASER1M

New

Description	Reference for Polar White	Unit MRP [₹]	Pack	Reference for Volcanic Grey	Unit MRP [₹]	Pack
Hotel Series*						
Cord Outlet	UNSCORD1M_WE	510	20	UNSCORD1M_GY	567	20
DND / MMR Indicator*	UNSDM1M	9537	20	-	-	-
DND/MMR Indicator v.2	UNSDM1M_WE	2057	-	UNSDM1M_GY	2350	-
DND Switch	UNSDNDSW1M_WE	696	10	UNSDNDSW1M_GY	849	10
MMR Switch	UNSMRWSW1M_WE	696	10	UNSMRWSW1M_GY	849	10
SW DND MMR with interlock	UNSDNDMMRWSW2M_WE	1160	10	UNSDNDMMRWSW2M_GY	1390	10
Electronic Keycard Switch, White	UNSEKCSW_WE	9257	5	UNSEKCSW_GY	10700	5
Electronic Keycard Switch, Sandy Beige	UNSEKCSW_CL	9670	5	UNSEKCSW_CD	9541	5
Curtain Control Switch	UNSCURTAINSW2M_WE	1290	10	UNSCURTAINSW2M_GY	1495	10
Shaver Socket	UNSSHAVER_WE	9664	1	UNSSHAVER_GY	10540	1
Skirt Light with LED, 2M	UNSSKTLT2M_WE	1711	10	UNSSKTLT2M_GY	2003	10
Door Chime 230V AC 2M	UNSICHIME2M_WE	1747	-	UNSICHIME2M_GY	1916	-
Modular ELV Push Button						
1 Gang ELV Switch	UNFLVPB1M1G_WE	1490	-	UNFLVPB1M1G_GY	1490	-
2 Gang ELV Switch	UNFLVPB1M2G_WE	2601	-	UNFLVPB1M2G_GY	2601	-

* Fully compatible with Miluz & Unica Pure

Description	Reference	Unit MRP [₹]	Pack
LED Phase Indicator			
LED Phase Indicator, Red	UNSPHASER1M	629	20
LED Phase Indicator, Green	UNSPHASEG1M	629	20
LED Phase Indicator, Yellow	UNSPHASEY1M	629	20

Please contact Customer Care Center for Stockable and Non stockable status of references.

*Bold references are MTO reference.

W.E.F. April 01st, 2026

Unica Pure - Irresistibly Beautiful



UNPGP2M



UNPGP6M

Description	Reference for Gridplate	Unit MRP [₹]	Pack
Cover Plates			
2 Module Gridplate (Fixing Frame) Only	UNPGP2M	210	4
3 Module Gridplate (Fixing Frame) Only	UNPGP3M	256	9
4 Module Gridplate (Fixing Frame) Only	UNPGP4M	295	8
6 Module Gridplate (Fixing Frame) Only	UNPGP6M	401	9
8 Module Gridplate (Fixing Frame) Only, Linear	UNPGP8ML	414	9
8 Module Gridplate (Fixing Frame) Only, Square	UNPGP8MSQ	529	6
12 Module Gridplate (Fixing Frame) Only	UNPGP12M	618	6



UNPSP2M_WD



UNPSP6M_WD

Description	Reference for Oak Wood	Unit MRP [₹]	Pack
Cover Plates			
1 Module Wood Cover Frame Only	UNPSP1M_WD	3043	6
2 Module Wood Cover Frame Only	UNPSP2M_WD	3234	6
3 Module Wood Cover Frame Only	UNPSP3M_WD	4003	6
4 Module Wood Cover Frame Only	UNPSP4M_WD	4632	6
6 Module Wood Cover Frame Only	UNPSP6M_WD	6610	3
8 Module Wood Cover Frame Only, Linear	UNPSP8ML_WD	8033	3
8 Module Wood Cover Frame Only, Square	UNPSP8MSQ_WD	9582	6
12 Module Wood Cover Frame Only	UNPSP12M_WD	12811	6



UNPSP2M_GW



UNPSP6M_GW



UNPSP2M_GB



UNPSP6M_GB

Description	Reference for Aqua Glass	Unit MRP [₹]	Pack	Reference for Pearl Black Glass	Unit MRP [₹]	Pack
Cover Plates						
1 Module Aqua Glass Cover Frame Only	UNPSP1M_GW	1682	6	UNPSP1M_GB	1992	6
2 Module Aqua Glass Cover Frame Only	UNPSP2M_GW	1892	6	UNPSP2M_GB	2240	6
3 Module Aqua Glass Cover Frame Only	UNPSP3M_GW	2131	6	UNPSP3M_GB	2435	6
4 Module Aqua Glass Cover Frame Only	UNPSP4M_GW	2227	6	UNPSP4M_GB	2640	6
6 Module Aqua Glass Cover Frame Only	UNPSP6M_GW	4023	3	UNPSP6M_GB	4658	3
8M Aqua Glass Cover Frame Only, Linear	UNPSP8ML_GW	4572	3	UNPSP8ML_GB	5385	3
8M Aqua Glass Cover Frame Only, Square	UNPSP8MSQ_GW	5790	6	UNPSP8MSQ_GB	6824	6
12 Module Aqua Glass Cover Frame Only	UNPSP12M_GW	7216	6	UNPSP12M_GB	8492	6

Please contact Customer Care Center for Stockable and Non stockable status of references.
*Bold references are MTO reference.

W.E.F. April 01st, 2026

Unica Pure - Irresistibly Beautiful



UNPSP2M_ML



UNPSP6M_ML

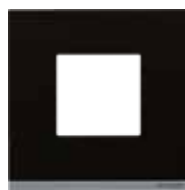

UNPSP2M_MD



UNPSP6M_MD

Description	Reference for Pewter Grey Metal	Unit MRP [₹]	Pack	Reference for Black Metal	Unit MRP [₹]	Pack
Cover Plates						
1 Module Pw Grey Metal Cover Frame Only	UNPSP1M_ML	3006	6	UNPSP1M_MD	3006	6
2 Module Pw Grey Metal Cover Frame Only	UNPSP2M_ML	3336	6	UNPSP2M_MD	3336	6
3 Module Pw Grey Metal Cover Frame Only	UNPSP3M_ML	3798	6	UNPSP3M_MD	3798	6
4 Module Pw Grey Metal Cover Frame Only	UNPSP4M_ML	3992	6	UNPSP4M_MD	3992	6
6 Module Pw Grey Metal Cover Frame Only	UNPSP6M_ML	7069	3	UNPSP6M_MD	7069	3
8Module Pw Grey Metal CF Only, Linear	UNPSP8ML_ML	7964	3	UNPSP8ML_MD	7964	3
8 Module Pw Grey Metal CF Only, Suare	UNPSP8MSQ_ML	10116	6	UNPSP8MSQ_MD	10116	6
12Module Pw Grey Metal Cover Frame Only	UNPSP12M_ML	12549	6	UNPSP12M_MD	12549	6



UNSCP2M_WE



UNSCP6M_WE



UNSCP2M_GY



UNSCP6M_GY



UNSCP2M_CD



UNSCP6M_CD



UNSCP2M_CL



UNSCP6M_CL

Description	Reference for Molded Polar White	Unit MRP [₹]	Pack	Reference for Molded Volcanic Grey	Unit MRP [₹]	Pack	Reference for Painted Mocha Brown	Unit MRP [₹]	Pack	Reference for Painted Sandy Biege	Unit MRP [₹]	Pack
Cover Plates												
1 Module Plastic Surround and Gridplate	UNSCP1M_WE	292	20	UNSCP1M_GY	415	20	UNSCP1M_CD	559	20	UNSCP1M_CL	569	20
2 Module Plastic Surround and Gridplate	UNSCP2M_WE	326	20	UNSCP2M_GY	465	20	UNSCP2M_CD	624	20	UNSCP2M_CL	645	20
3 Module Plastic Surround and Gridplate	UNSCP3M_WE	372	10	UNSCP3M_GY	529	10	UNSCP3M_CD	726	10	UNSCP3M_CL	724	10
4 Module Plastic Surround and Gridplate	UNSCP4M_WE	393	14	UNSCP4M_GY	566	14	UNSCP4M_CD	759	14	UNSCP4M_CL	759	14
6 Module Plastic Surround and Gridplate	UNSCP6M_WE	685	5	UNSCP6M_GY	977	5	UNSCP6M_CD	1307	5	UNSCP6M_CL	1352	5
8 Module Plastic Surround and Gridplate, Linear	UNSCP8ML_WE	771	5	UNSCP8ML_GY	1091	5	UNSCP8ML_CD	1475	5	UNSCP8ML_CL	1502	5
8 Module Plastic Surround and Gridplate, Square	UNSCP8MSQ_WE	997	10	UNSCP8MSQ_GY	1512	10	UNSCP8MSQ_CD	1866	10	UNSCP8MSQ_CL	1866	5
9 Module Plastic Surround and Gridplate	UNSCP9M_WE	1252	5	UNSCP9M_GY	1954	5	-	-	-	-	-	
12 Module Plastic Surround and Gridplate	UNSCP12M_WE	1394	5	UNSCP12M_GY	2451	5	UNSCP12M_CD	2359	5	UNSCP12M_CL	2355	5
16 Module Plastic Surround and Gridplate	UNSCP16M_WE	1715	5	UNSCP16M_GY	2959	5	UNSCP16M_CD	3193	5	UNSCP16M_CL	3193	5
18 Module Plastic Surround and Gridplate	UNSCP18M_WE	1778	1	UNSCP18M_GY	3159	1	UNSCP18M_CD	3422	1	UNSCP18M_CL	3422	1

Please contact Customer Care Center for Stockable and Non stockable status of references.

*Bold references are MTO reference.

W.E.F. April 01st, 2026



Wiring Diagram Unica Pure

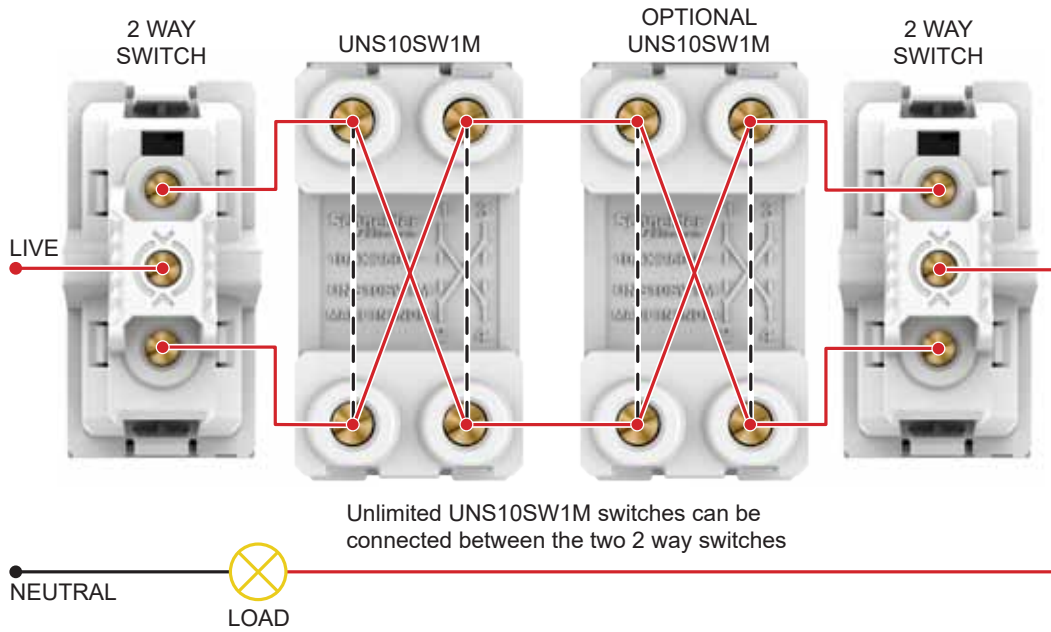

> 10AX Intermediate Switch

UNS10SW1M_WE, UNS10SW1M_GY

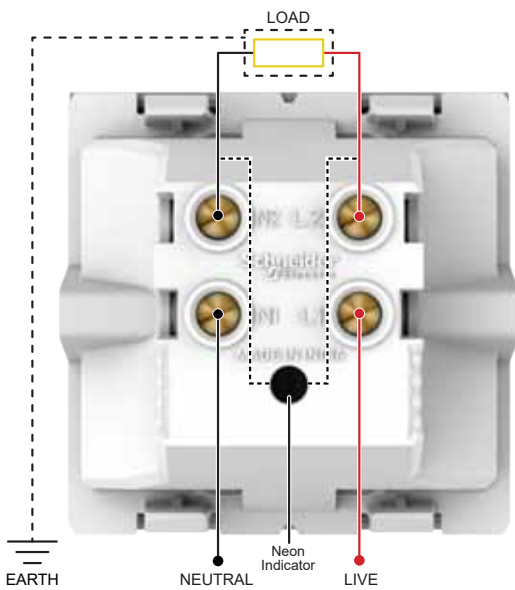

> 20A Double Pole Switch With Indicator

UNS20DP2M_WE, UNS20DP2M_GY

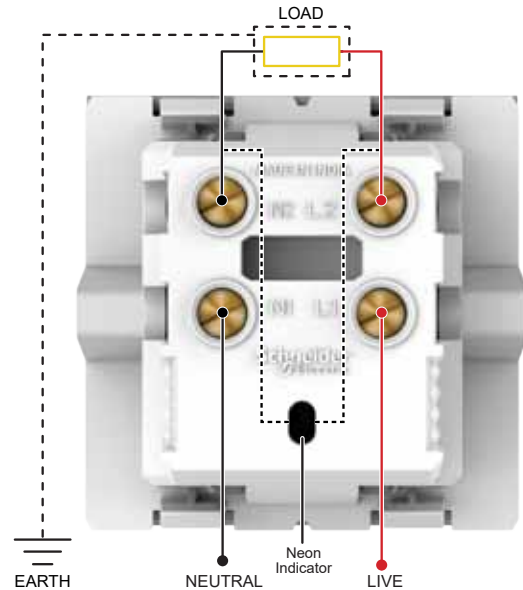

> 32A Double Pole Switch With Indicator

UNS32DP2M_WE, UNS32DP2M_GY

Wiring Diagram Unica Pure

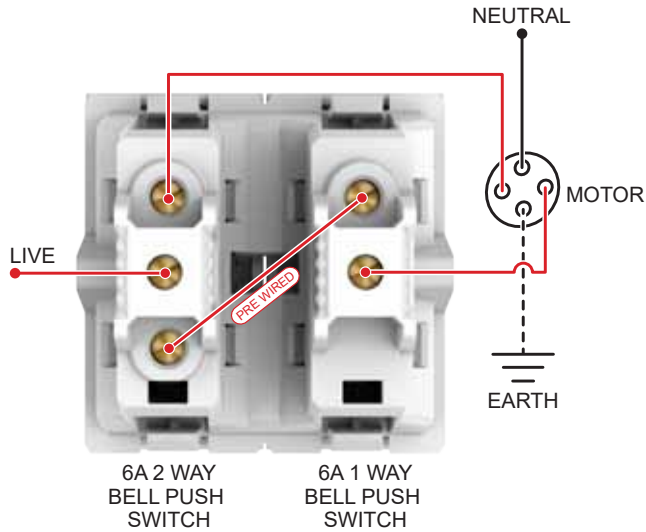

> Curtain Control Switch
UNSCURTAINSW2M_WE

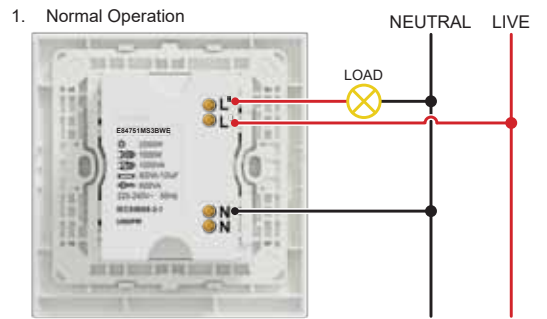

> PIR Motion Sensor*
UNSPIR_WE

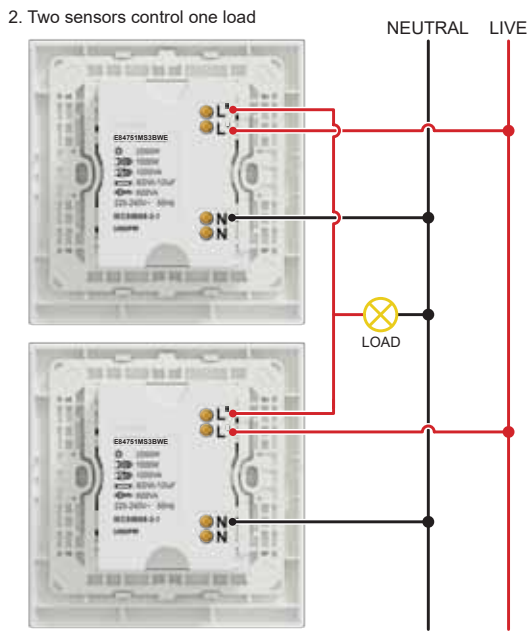

> PIR Motion Sensor*
UNSPIR_WE

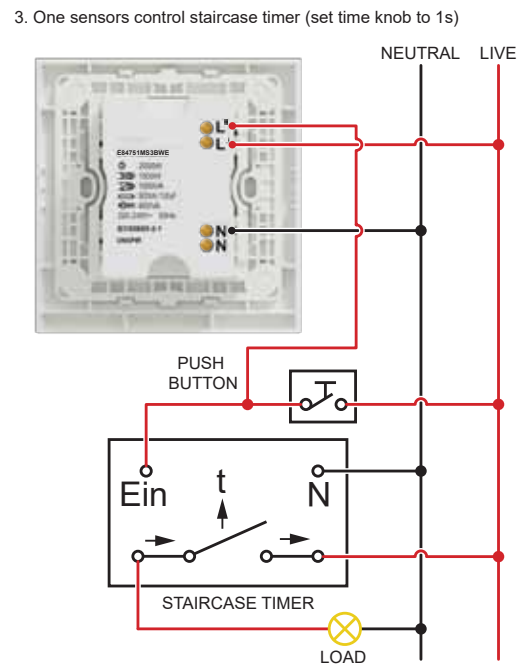

> PIR Motion Sensor*
UNSPIR_WE

Wiring Diagram Unica Pure

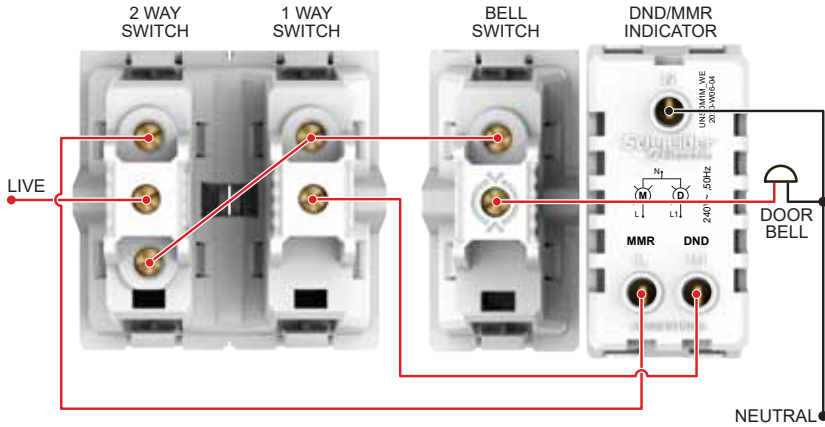

- > DND/MMR Indicator v.2
- > Do Not Disturb Switch
- > Make My Room Switch
- > DND Switch
- > MMR Switch

UNSDM1M_WE, UNSDM1M_GY, UNSDNDSW1M_WE,
UNSDNDSW1M_GY, UNSMMSW1M_WE, UNSMMSW1M_GY

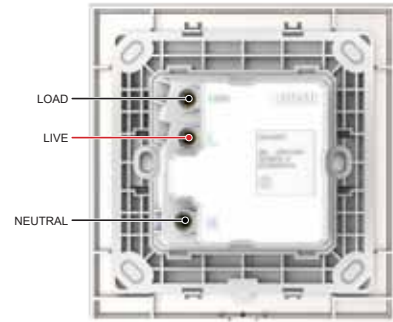

- > Unica Pure Key Card

UNSEKCSW_WE, UNSEKCSW_GY,
UNSEKCSW_CL, UNSEKCSW_CD

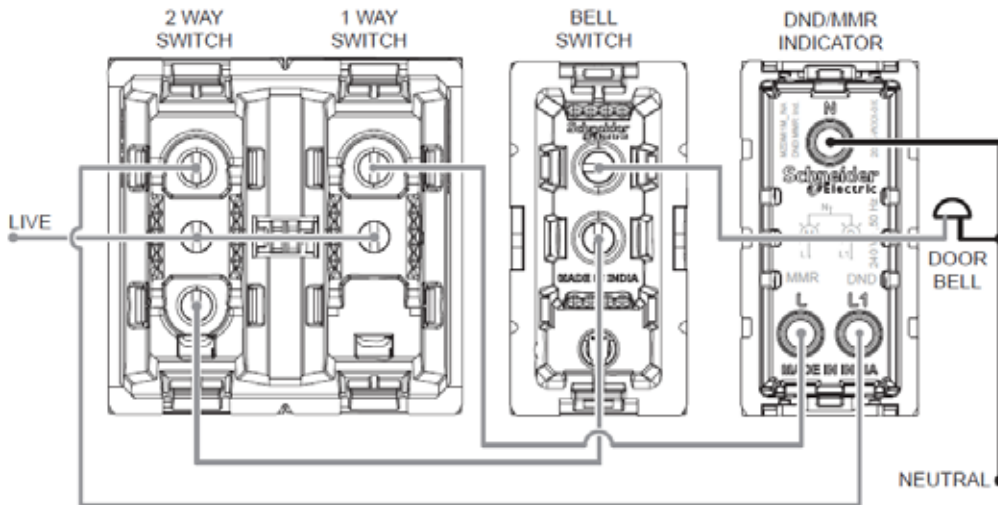

- > SW DNDMMR with interlock

UNSDNDMMRSW2M_WE & UNSDNDMMRSW2M_GY

ZENcelo India - The Revolutionary Full-Flat Switch



- **World's First and only Full-Flat Mechanical Switch**
- **Patented Iso-Motion Technology** - Ensures switch stays in the same position whether On or Off
- **Robust & Strong** - Made of corrosion-resistant, heat-resistant and impact-resistant polycarbonate
- **Safe to Use** - Electric arc encapsulated switches and Data Sockets with patented integrated shutter
- **Designed to Last** - Switches tested to 80,000 times; Sockets tested to 15,000 cycles.
- **Green & Eco Friendly** - RoHS compliant range
- **Dust Proof Cover**
- **All Dark Grey references covered with electrostatic protective film**
- **Intermediate switches to control multiple 2way switches**
- **16AX~20A 1 Way 2G Switch (1M) - IN8444/16: Single: switch to control two loads**



Description	Reference for White	Unit MRP [₹]	Pack	Reference for Dark Grey	Unit MRP [₹]	Pack
Switches						
6AX 1 Way switch	IN8401	496	10	IN8401(BZ)	621	10
6AX 1 Way switch (2M)	IN8421	891	10	IN8421(BZ)	1054	10
6AX 2 Way switch	IN8402	621	10	IN8402(BZ)	747	10
6AX 1 Way switch with Neon	IN8481	797	10	IN8481(BZ)	954	10
16AX~20A 1 Way switch	IN8401/16	758	10	IN8401/16(BZ)	922	10
16AX~20A 1 Way switch (2M)	IN8421/16	1178	10	-	-	-
16AX~20A 1 Way switch with Neon	IN8481/16	1087	10	IN8481/16(BZ)	1288	10
16AX~20A 1 Way switch with Neon (2M)	IN8482/16	1392	10	IN8482/16(BZ)	1654	10
16AX~20A 2 Way switch	IN8402/16	1075	10	IN8402/16(BZ)	1394	10
16AX~20A 2 Way switch (2M)	IN8422/16	1288	10	IN8422/16(BZ)	1661	10
16AX~20A 1 Way 2G switch (1M)	IN8444/16	1238	10	IN8444/16(BZ)	1507	10
10AX Intermediate switch	IN8430/IM	2054	10	-	-	-
6A Momentary Switch	IN8487	1015	10	IN8487_BZ	1198	-
20A DP Switch with Neon (2M)	IN8486/20	1658	5	IN8486/20(BZ)	2252	5
32A DP Switch with Neon (2M)	IN8486/32	2581	5	IN8486/32(BZ)	3216	5
Motor Starter Switch						
25A Motor Starter switch (2M)	IN8425MS	4403	10	IN8425MS(BZ)	4707	10
Bell Push						
6A Bell Push switch	IN8405	705	10	IN8405(BZ)	887	10
6A Bell Push switch (2M)	IN8425	1145	10	IN8425(BZ)	1413	10
6A Bell Push switch with Neon	IN8485	1035	10	IN8485(BZ)	1219	10
6A Bell Push switch with Neon (2M)	IN8486	1211	10	IN8486(BZ)	1555	10
Sockets						
6A 3 PIN Socket Outlet with Shutter (BIS)	IN8426UNS	819	10	IN8426UNS_BZ	992	10
6A/16A 3 Pin Socket with Shutter	IN8426/16	1219	10	IN8426/16(BZ)	1493	10
Fan Regulators & Dimmers						
Fan Control (5 Speeds)	IN84SFR	3036	5	IN84SFR(BZ)	3644	5
Full Flat 500W Dimmer Module (1 Gang)	IN8404D	2758	10	IN8404D(BZ)	3267	10
USB Chargers						
1 Gang USB Charger - 2.1A (1M)	IN8431USB_WE	4723	10	IN8431USB_BZ	5419	10
2.4A 5V A+C USB Charger (1M)	IN8431ACUSB_WE	5222	10	IN8431ACUSB_BZ	5985	10
Accessories						
RJ11 Telephone Outlet with shutter (1 Gang)	IN8431RJS4	814	10	IN8431RJS4(BZ)	1002	10
RJ45 Cat6 Data Outlet with shutter	IN8431RJ6	2875	10	IN8431RJ6(BZ)	3511	10
TV Socket	IN8431TV	622	10	IN8431TV(BZ)	800	10
Foot Lamp with White LED (2M)	IN8490FLW	5847	10	-	-	-
Foot Lamp with Yellow LED (2M)	IN8490FLY	5702	10	-	-	-
Blank off unit (1M)	IN8430X	185	10	IN8430X(BZ)	228	10
Door Chime 230VAC 2M	INCHIME8488	2822	-	INCHIME8488_BZ	3157	-
Hotel Series						
Do Not Disturb Panel	INH8451	4515	10	INH8451(BZ)	5104	10
Make My Room Panel	INH8454	4220	10	INH8454(BZ)	4710	10
Do Not Disturb Switch	INH8452	2241	10	INH8452(BZ)	2474	10
Do Not Disturb Switch (2M)	-	-	-	INH8453(BZ)	2774	10
Make My Room Switch	INH8455	2190	10	INH8455(BZ)	2608	10

Please contact Customer Care Center for Stockable and Non stockable status of references.
*Bold references are MTO reference.

W.E.F. April 01st, 2026



ZENcelo India - The Revolutionary Full-Flat Switch

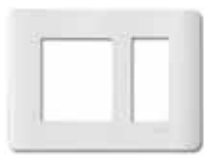

IN8403C

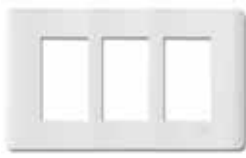

IN8406C



IN8402C(BZ)

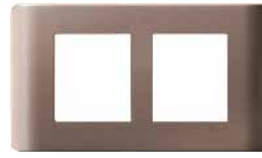

IN8404C(SZ)



IN84012C(SA)

Description	Reference for White	Unit MRP [₹]	Pack	Reference for Dark Grey	Unit MRP [₹]	Pack	Reference for Silver Bronze	Unit MRP [₹]	Pack	Reference for Satin Silver	Unit MRP [₹]	Pack
Cover Plates												
1M Grid & 1M Cover Frame	IN8401C	488	10	IN8401C(BZ)	606	10	IN8401C(SZ)	1424	10	IN8401C(SA)	1563	10
2M Grid & 2M Cover Frame	IN8402C	512	10	IN8402C(BZ)	636	10	IN8402C(SZ)	1410	10	IN8402C(SA)	1546	10
3M Grid & 3M Cover Frame	IN8403C	602	10	IN8403C(BZ)	750	10	IN8403C(SZ)	1733	10	IN8403C(SA)	1901	10
4M Grid & 4M Cover Frame	IN8404C	657	10	IN8404C(BZ)	881	10	IN8404C(SZ)	2082	10	IN8404C(SA)	2286	10
6M Grid & 6M Cover Frame	IN8406C	1002	5	IN8406C(BZ)	1251	5	IN8406C(SZ)	2859	5	IN8406C(SA)	3167	5
8M Grid & 8M Cover Frame - Horizontal	IN8408HC	1202	5	IN8408HC(BZ)	1496	5	IN8408HC(SZ)	3899	5	IN8408HC(SA)	4279	5
8M Grid & 8M Cover Frame - Square	IN8408SC	1603	5	IN8408SC(BZ)	2307	5	-	-	-	IN8408SC(SA)	5195	5
9M Grid & 9M Cover Frame	IN8409C	2207	5	-	-	-	IN8409C(SZ)	6546	5	-	-	-
12M Grid & 12M Cover Frame	IN84012C	2659	5	IN84012C(BZ)	3407	5	IN84012C(SZ)	8803	5	IN84012C(SA)	9661	5
18M Grid & 18M Cover Frame	IN84018C	3750	5	IN84018C(BZ)	5043	5	IN84018C(SZ)	11651	5	IN84018C(SA)	12789	5

Please contact Customer Care Center for Stockable and Non stockable status of references.

*Bold references are MTO reference.

W.E.F. April 01st, 2026

Wiring Diagram ZENcelo

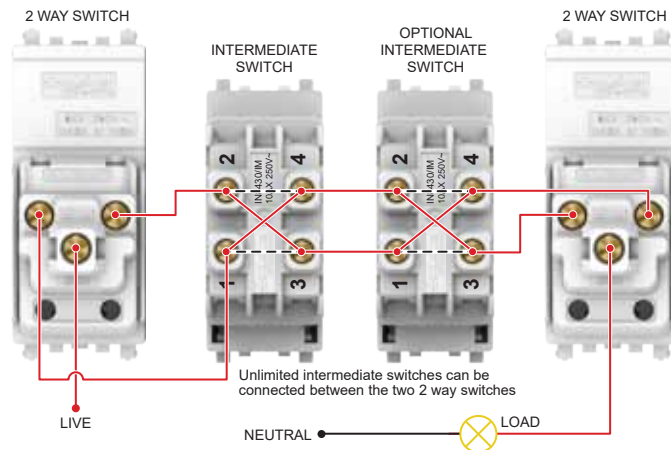

> 10AX Intermediate Switch

IN8430/IM, IN8430/IM (BZ)

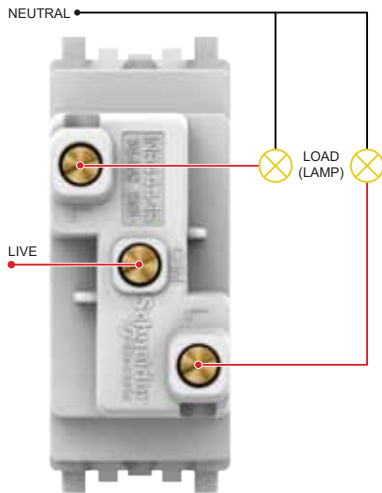

> 16AX~20A 1 Way 2G Switch (1M)

IN8444/16, IN8444/16 (BZ)

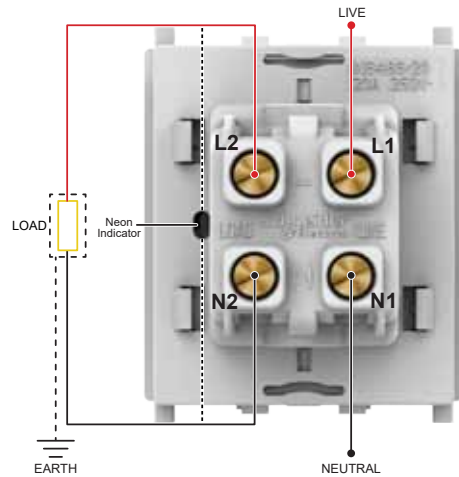

> 20A DP Switch with Neon (2M)

IN8486/20, IN8486/20 (BZ)

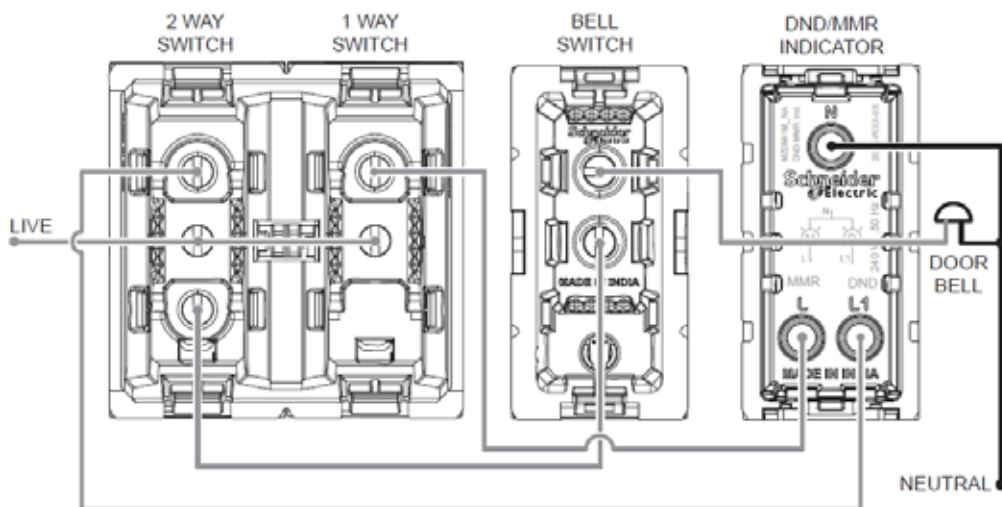

> SW DNDMMR White with interlock 2M

INH8456_WE & INH8456_BZ

Wiring Diagram ZENcelo

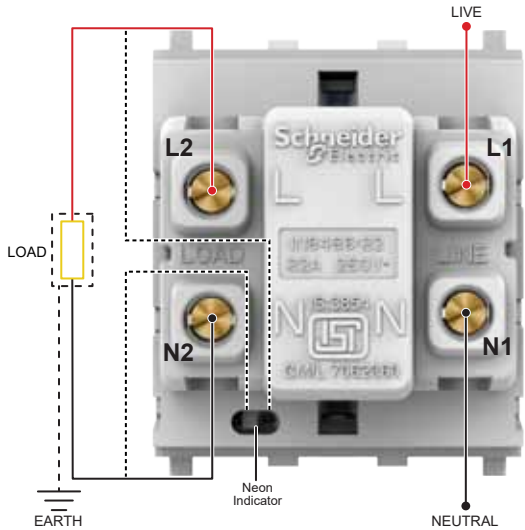

> 32A DP Switch with Neon (2M)

IN8486/32, IN8486/32 (BZ)

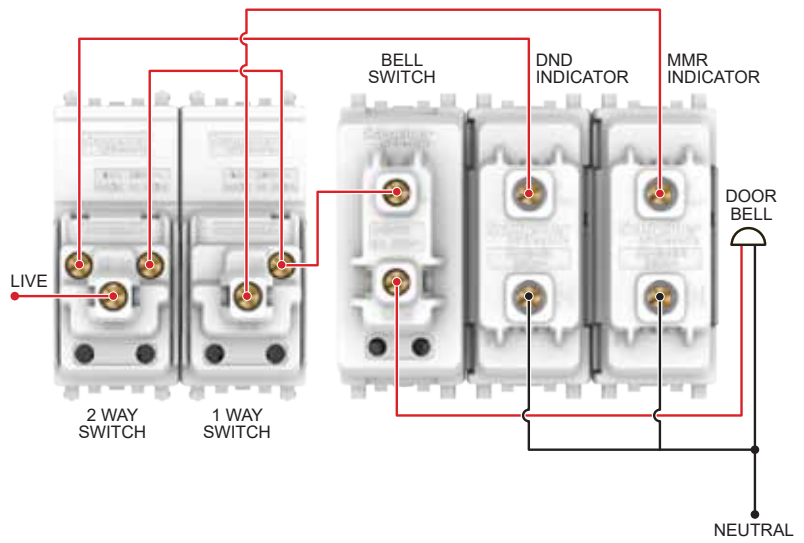

> Do Not Disturb Panel > Make My Room Panel
> Do Not Disturb Switch > Make My Room Switch

INH8451, INH8451 (BZ), INH8454, INH8454 (BZ),
INH8452, INH8452 (BZ), INH8455, INH8455 (BZ)

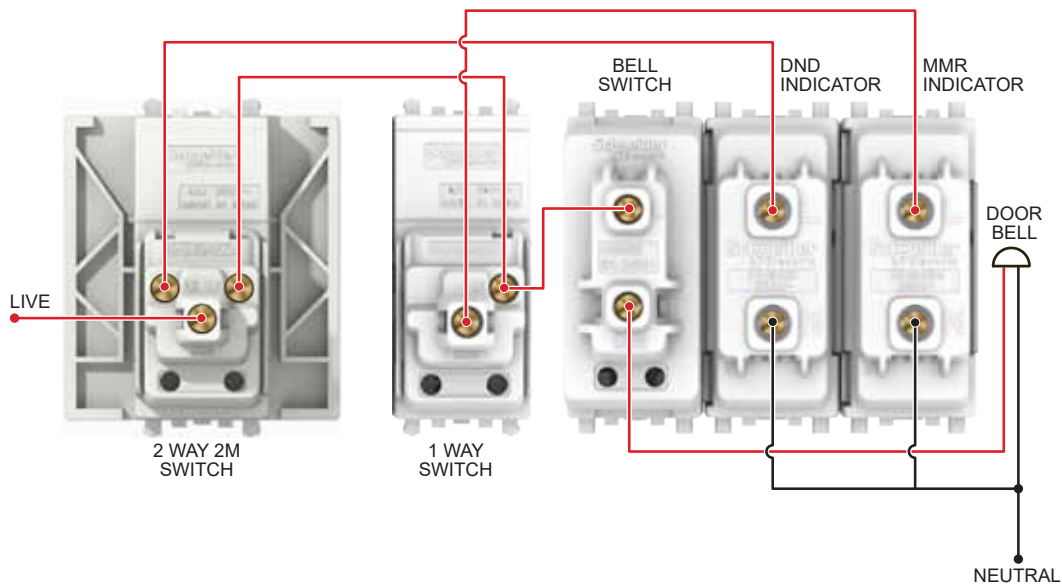

> Do Not Disturb Panel > Make My Room Panel
> Do Not Disturb Switch (2M) > Make My Room Switch

INH8451, INH8451 (BZ), INH8454, INH8454 (BZ)
INH8453 (BZ), INH8455, INH8455 (BZ)

AvatarOn - It's also a Switch



White (WE)



Wine Gold (WG)



Dark Grey (DG)



Dark Wood (WD)



Gold Hairline (GH)



Light Wood (LW)



Award-winning Designs: In 2017, AvatarOn gained international recognition for its innovative design and quality excellence and was awarded the iF Design Award

Ingenious Beauty

- The ground-breaking AvatarOn series is a true marriage of aesthetics and practicality, making it a perfect choice for all home or office designs.

Safe and Reliable

- Our patented "Slim Rocker, Sure Click" SS technology not only gives AvatarOn a greater thinness overall, but also a near-zero contact jitter that reduces sparks, thus ensuring a safe and reliable use.

Customisable Covers for True Adaptability

- AvatarOn switches are available in an array of replaceable covers for full customisation and integration into any home decor. The customised pattern covers of AvatarOn provides you with an extra canvas to showcase your creativity in a subtle yet apparent way.

Modern Look

- The stylish and streamlined design of AvatarOn switch covers are finished in white, soft wood, dark wood and gold hairline materials for a classic look and universal elegance.

Tech-chic Design that Shines

- The AvatarOn soft LED locators merges seamlessly with its sleek giant dolly, creating a stylish and streamlined design and glow with a soft luminescent in the dark, indicating the exact location of each switch at night.

Multifunctional Accessories for Every Day Conveniences

















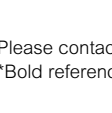

Product Description	Color	Product Ref. No.	Unit MRP [₹]	Pack
16A Switches (Base + Cover Plate)				
16AX 250V 1 Gang 1 Way Switch	White	E8331L1_WE_G8	726	1
	Wine Gold	E8331L1_WG_G8	1091	10
	Dark Grey	E8331L1_DG_G8	1091	1
	Metal Gold Hairline	E8331L1_GH_G8	1095	10
	Light Wood	E8331L1_LW_G8	1181	10
	Dark Wood	E8331L1_WD_G8	1095	10
16AX 250V 1 Gang 1 Way Switch with LED Indicator	White	E8331L1LED_WE_G8	1091	1
	Wine Gold	E8331L1LED_WG_G8	1631	10
	Dark Grey	E8331L1LED_DG_G8	1631	1
	Metal Gold Hairline	E8331L1LED_GH_G8	1639	10
	Light Wood	E8331L1LED_LW_G8	1926	10
	Dark Wood	E8331L1LED_WD_G8	1639	10
16AX 250V 1 Gang 2 Way Switch	White	E8331L2_WE_G8	750	1
	Wine Gold	E8331L2_WG_G8	1164	10
	Dark Grey	E8331L2_DG_G8	1164	1
	Metal Gold Hairline	E8331L2_GH_G8	1169	10
	Light Wood	E8331L2_LW_G8	1260	10
	Dark Wood	E8331L2_WD_G8	1169	10
16AX 250V 1 Gang 2 Way Switch with LED Indicator	White	E8331L2LED_WE_G8	1164	10
	Wine Gold	E8331L2LED_WG_G8	1747	10
	Dark Grey	E8331L2LED_DG_G8	1747	1
	Metal Gold Hairline	E8331L2LED_GH_G8	1756	10
	Light Wood	E8331L2LED_LW_G8	2064	10
	Dark Wood	E8331L2LED_WD_G8	1987	10
16AX 250V 2 Gang 1 Way Switch	White	E8332L1_WE_G8	1132	1
	Wine Gold	E8332L1_WG_G8	1699	10
	Dark Grey	E8332L1_DG_G8	1699	1
	Metal Gold Hairline	E8332L1_GH_G8	1715	10
	Light Wood	E8332L1_LW_G8	1789	10
	Dark Wood	E8332L1_WD_G8	1715	10
16AX 250V 2 Gang 1 Way Switch with LED Indicator	White	E8332L1LED_WE_G8	1699	1
	Wine Gold	E8332L1LED_WG_G8	2550	10
	Dark Grey	E8332L1LED_DG_G8	2550	1
	Metal Gold Hairline	E8332L1LED_GH_G8	2575	10
	Light Wood	E8332L1LED_LW_G8	3039	10
	Dark Wood	E8332L1LED_WD_G8	2575	10
16AX 250V 2 Gang 2 Way Switch	White	E8332L2_WE_G8	1378	1
	Wine Gold	E8332L2_WG_G8	2067	10
	Dark Grey	E8332L2_DG_G8	2067	1
	Metal Gold Hairline	E8332L2_GH_G8	2086	10
	Light Wood	E8332L2_LW_G8	2463	10
	Dark Wood	E8332L2_WD_G8	2086	10

Please contact Customer Care Center for Stockable and Non stockable status of references.

*Bold references are MTO reference.

W.E.F. April 01st, 2026

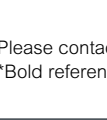
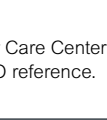
AvatarOn - It's also a Switch

		Product Description	Color	Product Ref. No.	Unit MRP ₹	Pack
16A Switches (Base + Cover Plate)						
		16AX 250V 2 Gang 2 Way Switch with LED Indicator	White	E8332L2LED_WE_G8	2067	10
			Wine Gold	E8332L2LED_WG_G8	3102	10
			Dark Grey	E8332L2LED_DG_G8	3102	1
			Dark Wood	E8332L2LED_WD_G8	3132	10
		16AX 250V 3 gang 1 Way Switch	White	E8333L1_WE_G8	1867	1
			Wine Gold	E8333L1_WG_G8	2801	10
		16AX 250V 3 gang 1 Way Switch with LED Indicator	Dark Grey	E8333L1_DG_G8	2854	1
			Metal Gold Hairline	E8333L1_GH_G8	2841	10
			Light Wood	E8333L1_LW_G8	2935	10
			Dark Wood	E8333L1_WD_G8	2841	10
		16AX 250V 3 gang 1 Way Switch with LED Indicator	White	E8333L1LED_WE_G8	2801	10
			Wine Gold	E8333L1LED_WG_G8	4199	10
		16AX 250V 3 gang 1 Way Switch with LED Indicator	Dark Grey	E8333L1LED_DG_G8	4199	1
			Metal Gold Hairline	E8333L1LED_GH_G8	4259	10
			Light Wood	E8333L1LED_LW_G8	4981	10
			Dark Wood	E8333L1LED_WD_G8	4259	10
		16AX 250V 3 gang 2 Way Switch	White	E8333L2_WE_G8	2009	1
			Wine Gold	E8333L2_WG_G8	3015	10
		16AX 250V 3 gang 2 Way Switch with LED Indicator	Dark Grey	E8333L2_DG_G8	3015	1
			Metal Gold Hairline	E8333L2_GH_G8	3059	10
			Dark Wood	E8333L2_WD_G8	3059	10
			White	E8333L2LED_WE_G8	3015	10
		16AX 250V 3 gang 2 Way Switch with LED Indicator	Wine Gold	E8333L2LED_WG_G8	4522	10
			Dark Grey	E8333L2LED_DG_G8	4522	1
			Metal Gold Hairline	E8333L2LED_GH_G8	4587	10
			Light Wood	E8333L2LED_LW_G8	5119	10
		16AX 250V 4 Gang 1 Way Switch	Dark Wood	E8333L2LED_WD_G8	4587	10
			White	E8334L1_WE_G8	2685	1
			Wine Gold	E8334L1_WG_G8	4030	10
			Dark Grey	E8334L1_DG_G8	4030	1
		16AX 250V 4 Gang 1 Way Switch	Metal Gold Hairline	E8334L1_GH_G8	4086	10
			Light Wood	E8334L1_LW_G8	4222	10
			Dark Wood	E8334L1_WD_G8	4086	10
			White	E8334L1LED_WE_G8	4030	10
		16AX 250V 4 Gang 1 Way Switch with LED Indicator	Wine Gold	E8334L1LED_WG_G8	6042	10
			Dark Grey	E8334L1LED_DG_G8	6042	1
			Metal Gold Hairline	E8334L1LED_GH_G8	6129	10
			Light Wood	E8334L1LED_LW_G8	7167	10
		16AX 250V 4 Gang 1 Way Switch with LED Indicator	Dark Wood	E8334L1LED_WD_G8	6129	10
			White	E8334L2_WE_G8	3089	1
			Wine Gold	E8334L2_WG_G8	4631	10
			Dark Grey	E8334L2LED_WE_G8	4631	10
		16AX 250V 4 Gang 2 Way Switch with LED Indicator	Wine Gold	E8334L2LED_WG_G8	6949	10
			Dark Grey	E8334L2LED_DG_G8	6949	1
			Metal Gold Hairline	E8334L2LED_GH_G8	7048	10
			White	E8334L2LED_WE_G8	4631	10

Please contact Customer Care Center for Stockable and Non stockable status of references.
*Bold references are MTO reference.

W.E.F. April 01st, 2026

AvatarOn - It's also a Switch



E8331M_WE_G8



E8331PRL1_WD_G8



E8332PRL1_WE_G8



E8332PRL1_WD_G8



E8331D20N_WE_G8



E8331D20N_WD_G8



E8331D32N_WE_G8



E8332D20N_WD_G8



E8331D32N_WD_G8



E8331D45N_WD_G8

Product Description	Color	Product Ref. No.	Unit MRP ₹	Pack
16A Intermediate Switches				
16AX 250V 1 Gang Intermediate Switch	White	E8331M_WE_G8	2497	1
	Wine Gold	E8331M_WG_G8	3746	1
	Dark Grey	E8331M_DG_G8	3746	1
10A Momentary Switches				
10A 250V 1 Gang Momentary Switch	Dark Wood	E8331PRL1_WD_G8	1335	10
	White	E8332PRL1_WE_G8	1121	10
	Wine Gold	E8332PRL1_WG_G8	1678	10
	Dark Grey	E8332PRL1_DG_G8	1678	1
	Metal Gold Hairline	E8332PRL1_GH_G8	1678	10
10A 250V 2 Gang Momentary Switch	Dark Wood	E8332PRL1_WD_G8	1678	10
	Dark Wood	E8332PRL1_WD_G8	1678	10
Double Pole Switches				
20A 250V 1 Gang Double Pole Switch with LED Indicator	White	E8331D20N_WE_G8	1922	10
	Wine Gold	E8331D20N_WG_G8	2878	10
	Dark Grey	E8331D20N_DG_G8	2878	1
	Metal Gold Hairline	E8331D20N_GH_G8	2906	10
	Light Wood	E8331D20N_LW_G8	2827	10
	Dark Wood	E8331D20N_WD_G8	2906	10
20A 250V 2 Gang Double Pole Switch with LED Indicator	White	E8332D20N_WE_G8	2446	10
	Wine Gold	E8332D20N_WG_G8	3455	10
	Dark Grey	E8332D20N_DG_G8	3455	1
	Metal Gold Hairline	E8332D20N_GH_G8	3488	10
	Dark Wood	E8332D20N_WD_G8	3488	10
32A 250V 1 Gang Double Pole Switch with LED Indicator	White	E8331D32N_WE_G8	2549	10
	Wine Gold	E8331D32N_WG_G8	3822	10
	Dark Grey	E8331D32N_DG_G8	3822	1
	Metal Gold Hairline	E8331D32N_GH_G8	3858	10
	Light Wood	E8331D32N_LW_G8	3858	10
	Dark Wood	E8331D32N_WD_G8	3858	10
45A 250V 1 Gang Double Pole Switch with LED Indicator	Wine Gold	E8331D45N_WG_G8	4779	10
	Dark Grey	E8331D45N_DG_G8	4865	1
	Metal Gold Hairline	E8331D45N_GH_G8	4912	10
	Dark Wood	E8331D45N_WD_G8	4604	10

Please contact Customer Care Center for Stockable and Non stockable status of references.
*Bold references are MTO reference.

W.E.F. April 01st, 2026

AvatarOn - It's also a Switch

		Product Description	Color	Product Ref. No.	Unit MRP ₹	Pack
Bell Push Switch						
 E8331BPL1_WE_G8	 E8331BPL1_WD_G8	10A 250V Door Bell Push Switch	White	E8331BPL1_WE_G8	813	1
			Wine Gold	E8331BPL1_WG_G8	1223	10
			Dark Grey	E8331BPL1_DG_G8	1217	1
			Metal Gold Hairline	E8331BPL1_GH_G8	1235	10
			Light Wood	E8331BPL1_LW_G8	1246	10
			Dark Wood	E8331BPL1_WD_G8	1235	10
Sockets						
 E8315_6_NS_WE	 E8315_6_NS_WD	6A 2/3 Pin Switched Socket	White	E8315_6_NS_WE	1619	8
			Wine Gold	E8315_6_NS_WG	2097	8
			Dark Grey	E8315_6_NS_DG	2058	1
			Metal Gold Hairline	E8315_6_NS_GH	2078	8
			Light Wood	E8315_6_NS_LW	2157	8
			Dark Wood	E8315_6_NS_WD	2078	8
 E8331FR350_WE_G8	 E8331FR350_WD_G8	6/16A Switched Socket	White	E8315_16_WE	2031	8
			Wine Gold	E8315_16_WG	2583	8
			Dark Grey	E8315_16_DG	2583	1
			Metal Gold Hairline	E8315_16_GH	2657	8
			Light Wood	E8315_16_LW	2707	8
			Dark Wood	E8315_16_WD	2608	8
Fan Regulators						
 E8331_WE	 E8331_WD	5 Steps 360 Deg Fan Regulator	White	E8331FR350_WE_G8	3857	1
			Wine Gold	E8331FR350_WG_G8	5084	1
			Dark Grey	E8331FR350_DG_G8	5084	1
			Metal Gold Hairline	E8331FR350_GH_G8	5084	1
			Light Wood	E8331FR350_LW_G8	5425	1
			Dark Wood	E8331FR350_WD_G8	5084	1
Switch & Socket Covers (Additional)						
 E8331KH_WE	 E8332_WD	1 Gang Switch Cover	White	E8331_WE	221	1
			Wine Gold	E8331_WG	611	1
			Metal Gold Hairline	E8331_GH	890	1
			Dark Wood	E8331_WD	611	1
 E8332_WE	 E8332_WD	1 Gang Switch Cover with Keyholder	White	E8331KH_WE	526	1
			White	E8332_WE	333	1
			Wine Gold	E8332_WG	834	1
			Metal Gold Hairline	E8332_GH	834	1
			Light Wood	E8332_LW	857	1
 E8332_WE	 E8333_WE	2 Gang Switch Cover	Dark Wood	E8332_WD	834	1
			White	E8333_WE	515	1
			Wine Gold	E8333_WG	1226	1
			Metal Gold Hairline	E8333_GH	1226	1
			Light Wood	E8333_LW	1203	1

Please contact Customer Care Center for Stockable and Non stockable status of references.
 *Bold references are MTO reference.

W.E.F. April 01st, 2026

AvatarOn - It's also a Switch



E8334_WE



E8334_WD



E8315C_6_NC_WE



E8315C_6_NC_WD



E8332USB_WE_G8



E8315C_16_WD



E8332ACQUSB_WE



E8332USB_WD_G8



E8331_26_WE

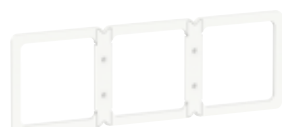

E8331_36_WE

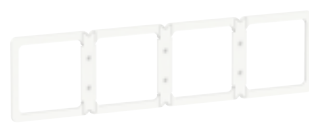

E8331_46_WE



E8330TX_WE

Product Description	Color	Product Ref. No.	Unit MRP ₹	Pack
4G Switch Cover	White	E8334_WE	805	1
	Wine Gold	E8334_WG	1504	1
	Dark Grey	E8334_DG	1437	1
	Metal Gold Hairline	E8334_GH	1671	1
	Light Wood	E8334_LW	1642	1
	Dark Wood	E8334_WD	1504	1
6A 2/3 Pin Switched Socket Cover	White	E8315C_6_NC_WE	575	12
	Wine Gold	E8315C_6_NC_WG	974	12
	Dark Grey	E8315C_6_NC_DG	974	1
	Metal Gold Hairline	E8315C_6_NC_GH	974	12
	Light Wood	E8315C_6_NC_LW	1125	12
	Dark Wood	E8315C_6_NC_WD	974	12
	16A 2/3 Pin Switched Socket Cover	Wine Gold	E8315C_16_WG	1019
Dark Grey		E8315C_16_DG	1019	1
Metal Gold Hairline		E8315C_16_GH	1131	12
Light Wood		E8315C_16_LW	1122	12
Dark Wood		E8315C_16_WD	1131	12
USB Chargers				
2 x 2.1A USB Charger with Mobile Holder (2.1A with 2 outputs used simultaneously)	White	E8332USB_WE_G8	9670	1
	Wine Gold	E8332USB_WG_G8	14507	1
	Dark Grey	E8332USB_DG_G8	14507	1
	Metal Gold Hairline	E8332USB_GH_G8	14507	1
	Light Wood	E8332USB_LW_G8	17193	1
	Dark Wood	E8332USB_WD_G8	14507	1
	Metal Gold Hairline	E8332ACQUSB_GH	8802	-
21W Type A+C, PD+QC3.0 USB Charger	Light Wood	E8332ACQUSB_LW	9434	-
	Dark Wood	E8332ACQUSB_WD	8802	-
	White	E8332ACQUSB_WE	7115	-
	Wine Gold	E8332ACQUSB_WG	8802	-
Blacket/Frame (to ensure alignment of switches on 2/3/4 Gang metal box)				
2 Gang Blacket/Frame	White	E8331_26_WE	365	1
	Wine Gold	E8331_26_WG	478	1
	Dark Grey	E8331_26_DG	455	1
3 Gang Blacket/Frame	White	E8331_36_WE	402	1
	Wine Gold	E8331_36_WG	563	1
	Dark Grey	E8331_36_DG	537	1
4 Gang Blacket/ Frame	White	E8331_46_WE	429	1
	Wine Gold	E8331_46_WG	604	1
	Dark Grey	E8331_46_DG	576	1
Blank Plates				
1 Gang Blank Plate	White	E8330X_WE	490	1
	Wine Gold	E8330X_WG	737	1
	Dark Grey	E8330X_DG	737	1
	Metal Gold Hairline	E8330X_GH	771	1
	Dark Wood	E8330X_WD	771	1
2 Gang Blank Plate	White	E8330TX_WE	685	10
	Wine Gold	E8330TX_WG	1063	10
	Dark Grey	E8330TX_DG	1063	1
	Metal Gold Hairline	E8330TX_GH	2947	10

Please contact Customer Care Center for Stockable and Non stockable status of references.
*Bold references are MTO reference.

W.E.F. April 01st, 2026

AvatarOn - It's also a Switch



E8331BPDMW_WE_G8



E8331KPB_WE



E8332C_WE_G8



E8332C_WD_G8



E83T727V_WE



E83T727V_WD



E8331RJS4_WE



E8331RJS4_WD

Product Description	Color	Product Ref. No.	Unit MRP ₹	Pack
Hotel Series				
DND, PCU, PW Indicator with Bell Switch (Do Not Disturb, Please Clean Up, Please Wait)	White	E8331BPDMW_WE_G8	7042	1
	Wine Gold	E8331BPDMW_WG_G8	10562	10
	Dark Grey	E8331BPDMW_DG_G8	10562	1
16AX 3 Gang Switch with PCU, DND, PW Sym (Do Not Disturb, Please Clean Up, Please Wait)	White	E8333DMWS_WE_G8	6702	1
	Wine Gold	E8333DMWS_WG_G8	9779	10
	Dark Grey	E8333DMWS_DG_G8	10244	1
	Dark Wood	E8333DMWS_WD_G8	10435	10
250V 16A Electronic Keycard Switch	White	E8331EKT_WE	12536	1
	Wine Gold	E8331EKT_WG	18806	1
	Dark Grey	E8331EKT_DG	18805	1
Panic Button with Key Reset	Dark Wood	E8331EKT_WD	19700	1
	White	E8331KPB_WE	2352	1
	Wine Gold	E8331KPB_WG	3456	1
10A 2 Gang Mechanical Curtain Switch	Dark Grey	E8331KPB_DG	2971	1
	White	E8332C_WE_G8	1459	1
	Wine Gold	E8332C_WG_G8	2189	10
	Dark Grey	E8332C_DG_G8	2189	1
	Metal Gold Hairline	E8332C_GH_G8	2189	10
115/240V 20VA Universal Version Shaver	Light Wood	E8332C_LW_G8	2433	10
	Dark Wood	E8332C_WD_G8	2189	10
	White	E83T727V_WE	6958	1
	Wine Gold	E83T727V_WG	11269	1
	Dark Grey	E83T727V_DG	11808	1
Connection Units	Metal Gold Hairline	E83T727V_GH	11808	1
	Dark Wood	E83T727V_WD	12370	1
	Wine Gold	E8331DFSGN_WG	6339	10
25A 250V 1 Gang Connection Unit	Metal Gold Hairline	E8331TB_GH	2743	10
Telecom, Network, Connectivity & Media Series				
1 Gang Telephone Socket, Shuttered Wallplate	White	E8331RJS4_WE	1084	1
	Wine Gold	E8331RJS4_WG	1808	1
	Dark Grey	E8331RJS4_DG	1808	1
	Metal Gold Hairline	E8331RJS4_GH	1808	1
	Light Wood	E8331RJS4_GH	1808	1
	Dark Wood	E8331RJS4_WD	1808	1

Please contact Customer Care Center for Stockable and Non stockable status of references.
*Bold references are MTO reference.

W.E.F. April 01st, 2026

AvatarOn - It's also a Switch



E8332RJS4_WE



E8331RJS5_WE



E8332RJS5_WE



E8331RJS6_WE



E8332RJS6_WE



E8331TV_WE



E8331TVSF_WE



E8332TDRJS5_WE



E8332TVRJS5_WE



E8332HDUSB_WE



E8332HDHD_WE



E8331RJS_WE



E8332RJS_WE

Product Description	Color	Product Ref. No.	Unit MRP ₹	Pack
2G Tel Socket, Shuttered Wallplate	White	E8332RJS4_WE	2661	1
	Wine Gold	E8332RJS4_WG	3996	1
1 Gang RJ45 Data Cat5E, Shuttered	White	E8331RJS5_WE	1695	1
	Wine Gold	E8331RJS5_WG	2957	1
	Dark Grey	E8331RJS5_DG	2822	1
	Metal Gold Hairline	E8331RJS5_GH	2822	1
	Dark Wood	E8331RJS5_WD	2957	1
2 Gang RJ45 Data Cat5E, Shuttered	White	E8332RJS5_WE	3099	1
	Wine Gold	E8332RJS5_WG	5168	1
	Dark Grey	E8332RJS5_DG	4933	1
1 Gang RJ45 Data Cat6, Shuttered	Metal Gold Hairline	E8332RJS5_GH	4933	10
	White	E8331RJS6_WE	2026	1
	Wine Gold	E8331RJS6_WG	3037	1
2 Gang RJ45 Data Cat6, Shuttered	Dark Grey	E8331RJS6_DG	3037	1
	White	E8332RJS6_WE	3795	1
	Wine Gold	E8332RJS6_WG	5694	1
1 Gang TV Socket, 75Ω, Through-Connect	Dark Grey	E8332RJS6_DG	5694	1
	White	E8331TV_WE	855	1
	Wine Gold	E8331TV_WG	1424	1
	Dark Grey	E8331TV_DG	1424	1
	Metal Gold Hairline	E8331TV_GH	1424	10
1 Gang TV Socket, Slave 5-1000	Dark Wood	E8331TV_WD	1424	1
	White	E8331TVSF_WE	945	10
	Wine Gold	E8331TVSF_WG	1583	0
1 Gang Tel + RJ45 Data Cat5E, Shuttered	Dark Grey	E8331TVSF_DG	1508	1
	White	E8332TDRJS5_WE	2661	1
	Wine Gold	E8332TDRJS5_WG	4437	1
	Dark Grey	E8332TDRJS5_DG	4236	1
	Metal Gold Hairline	E8332TDRJS5_GH	4236	1
1 Gang TV+ RJ45 Data Cat5E, Shuttered	Dark Wood	E8332TDRJS5_WD	4437	1
	White	E8332TVRJS5_WE	3300	1
	Wine Gold	E8332TVRJS5_WG	5507	1
	Dark Grey	E8332TVRJS5_DG	5255	1
	Metal Gold Hairline	E8332TVRJS5_GH	5255	1
1 Gang TV+ RJ45 Data Cat6, Shuttered	Dark Wood	E8332TVRJS5_WD	6118	1
	White	E8332TVRJS6_WE	3300	1
	Wine Gold	E8332TVRJS6_WG	5507	1
HDMI + USB Socket	Dark Grey	E8332TVRJS6_DG	5255	1
	White	E8332HDUSB_WE	7033	1
	Wine Gold	E8332HDUSB_WG	11720	8
2 Gang HDMI+HDMI, Keystone on Wallplate	Dark Grey	E8332HDUSB_DG	11187	1
	White	E8332HDHD_WE	3857	1
Volume Control, 5W, 8Ohm	Wine Gold	E8331VC_WG	4648	10
	Dark Grey	E8331VC_DG	4645	1
1 Gang S Keystone Wallplate (w/o Mod)	White	E8331RJS_WE	855	10
	Wine Gold	E8331RJS_WG	1282	10
	Dark Grey	E8331RJS_DG	1316	1
2 Gang S Keystone Wallplate (w/o Mod)	White	E8332RJS_WE	1563	10
	Wine Gold	E8332RJS_WG	2343	10
	Dark Grey	E8332RJS_DG	2342	1

Please contact Customer Care Center for Stockable and Non stockable status of references.
*Bold references are MTO reference.

W.E.F. April 01st, 2026

Kavacha - Weather Protected Series



CSW110-GY-EX



A3031WBP_WE

- Pleasing looks with **IP56 protection**
- Large press switch
- Co-moulded sealing with no risk of gasket damage
- Chemical resistant & UV stabilised

Description	Reference	Unit MRP [₹]	Pack
Kavacha IP56 Surface Mount Combined Switched Socket Outlets			
Combination Switch Socket Outlets			
16A Single Pole Switched Socket Outlet	CSC316RP_GY	5318	1
Kavacha IP56 Surface Mount Socket Outlets			
16A Socket Outlet	CSO316RP-GY-EX	3757	1
Kavacha Full-Time Weatherproof Cover			
Full-Time Weatherproof Single Gang Socket Cover (Transparent) IP55	E223R_TR	1360	1
Weatherproof Bell Press Grey	A3031WBP_GY	2077	1
Weatherproof Bell Press White	A3031WBP_WE	1815	1

Please contact Customer Care Center for Stockable and Non stockable status of references.
*Bold references are MTO reference.

W.E.F. April 01st, 2026

Metal Boxes



- **Weld free design** to minimize corrosion and rusting without compromising on strength
- Mounting clip and earth pin designed for **easier installation** and to **avoid loss during transportation**
- Removable side plates and optimized knock outs and for **easier wiring**
- Completely tested & validated as per **IS 14772**

Description	Reference	Unit MRP ₹	Pack
Metal Boxes for Indian Format Ranges (Livia, Opale, Clipsal X, Unica Pure & ZENcelo India)			
0.8 mm thickness			
Metal Box 1 & 2 modules	ME0102	121	20
Metal Box 3 modules	ME0103	158	20
Metal Box 4 modules	ME0104	181	20
1 mm thickness			
Metal Box 1 & 2 modules	MR1102	135	20
Metal Box 3 modules	MR1103	178	20
Metal Box 4 modules	MR1104	205	20
Metal Box 6 modules	MR1106	279	10
Metal Box 8 modules - Horizontal	MR1108	362	10
Metal Box 8 modules - Square	MR1109	362	10
Metal Box 12 module	MR1112	465	5
Metal Box 18 modules	MR1118	552	5

Description	Reference	Unit MRP ₹	Pack
Metal Boxes for BS Format Ranges (AvatarON) - New & Improved Design			
Use Bracket/Frame to ensure alignment of switches on 2/3/4 Gang Metal Box (refer to AvatarOn section for references)			
1 mm thickness			
2 GANG GI Metal Boxes	MM1102	353	20
3 GANG GI Metal Boxes	MM1103	499	20
4 GANG GI Metal Boxes	MM1104	646	20

- Special Metal Box with Gang Partition to accommodate BS format ranges
- Single Metal Box can accommodate up to 4 units
- Number of Gangs for Metal Box = Number of units that it can accommodate (Eg. 3 GANG Metal Box can accommodate up to 3 BS format Units)

Please contact Customer Care Center for Stockable and Non stockable status of references.
*Bold references are MTO reference.

W.E.F. April 01st, 2026

Smart Home Energy Management System



The Future of Homes
It's Time to
Get **Wiser**



Smart Home **Energy Management** System

With the rise of the Internet of Things (IoT), automation has simplified our lives and made our homes smarter. Smart homes, the foundation of smart cities, offer a more secure lifestyle by automating functions and providing greater control over living spaces.

Introducing **Wiser**, the next leap in Home Energy Management. Schneider Electric's vision for a sustainable, connected home of the future enables every device to be easily controlled and personalized through the Wiser Home Application.

Wiser offers an intuitive system with tools to control electricity usage and optimize energy needs without sacrificing comfort. It goes beyond convenience and security, empowering smarter, more sustainable living. Wiser homes focus on people, adding a new dimension to Stylish, Smart, Sustainable and Safe.

Together, we are creating the homes of the future by connecting electricity with digital solutions to help you achieve your sustainability goals.

Home Automation Possibilities



Semi Home Automation

- Lighting Control
- Fan Control
- HVAC Control
- Curtain Control
- Dimming – 10-100%
- Voice, App Control



Full Home Automation

- Mood Creation
- Geo-Fencing
- Digital Door-Lock Integration
- Sensor Based Automation
- Air Quality Management



Safety

- Appliance Protection
- Arc Fault Protection
- Thermal Protection



Home Energy Management

- Energy Monitoring
- Energy Efficiency Features
- Prosumer Management
- NEL Integration



AI / Machine Learning

- Lifestyle Recommendations
- Energy Saving Tips
- Appliance Management Tips



Wiser: One System. Infinite Control.

Make your home **Smart** and **Sustainable** with **Wiser**



SE Ref.	Description of reference	Unit MRP [₹]
CS16A1MSW_WE*	16A 1M Connected Switch, White	7200
CS16A1MSW_GY*	16A 1M Connected Switch, Grey	9450
CD4SFR2M_WE*	4 Step Connected Fan Regulator, White	7600
CD4SFR2M_GY*	4 Step Connected Fan Regulator, Grey	9800
ENMOD1P*	Energy Monitoring Device, Single Phase	On Request
ENMOD3P*	Energy Monitoring Device, Three Phase	On Request
CCIRC1M*	IR Controller- Wi-Fi	On Request
CR2CHRLYPG*	5A 2 Channel Relay Puck- Wi-Fi	On Request
CDWRLY1CH16A*	16A 1 Channel Connected Relay Puck- Wi-Fi	On Request
B1GTEWY*	Multi-Protocol Gateway	On Request
IH100WFVDP*	Smart Doorbell	On Request
IH14000100*	4 Channel Automation Relay	On Request
IH1200010F*	Fan Speed Controller	On Request
IH12000020*	2 Channel Dimmer Controller	On Request
IH101ZW2IR*	ZW_IR Controller	On Request
IH11000200*	2 Channel Curtain Controller	On Request
IH101ZWIFI*	Automation Gateway	On Request

Please contact Customer Care Center for Stockable and Non stockable status of references.

*Bold references are MTO reference.

Surface and Flush Mount Occupancy Sensors



PIR, Ultrasonic Sensors & High Frequency sensor suitable for both Surface & Flush Mount

Description	Reference	Unit MRP [₹]
Surface Mount Single-Load 360 degrees PIR	CSS54E_WE	4140
Flush/Surface Mount Single-Load 360 degrees PIR	SAE-UE-MS-CSAWE	5043
ARGUS Presence Dual-Tech PIR & Ultrasonic Sensor - 1ch	CCT551011	16588
ARGUS Presence Dual-Tech PIR & Ultrasonic Sensor - 2ch	CCT551012	17821
ARGUS IR Remote Controller Dual-Tech	CCT556011	23596
ARGUS Presence High Frequency High Bay Sensor - 2ch	CCT551023	19503
ARGUS IR Remote Controller HF	CCT556023	21631
ARGUS Presence Wide Sense - 2ch	CCT551003	16514
INFRASCAN OUTDOOR 3WIRE 10A	750WPR-GY	25305
INFRASCAN INDOOR 3WIRE 10A	751R-WE	14682
INFRASCAN 360 DEGREE 3WIRE	753R-WE	12752



PIR Flush Mount Sensors

Description	Reference	Unit MRP [₹]
ARGUS Standard min 360° False ceiling indoor movement detector	CCT570005	5902
ARGUS Standard 360° False ceiling indoor movement detector - 2ch	CCT570003	8664
Flush Mount Dual load 360 degrees standalone sensor	SAE-UE-MS-CDBWE	9864



Dimmable Sensors with Light Regulation

Dali Dimmable Sensor

Description	Reference	Unit MRP [₹]
ARGUS Presence Master with IR, DALI	MTN5510-1519	17821

Please contact Customer Care Center for Stockable and Non stockable status of references.
*Bold references are MTO reference.

W.E.F. April 01st, 2026

Wall Mount Sensors



BS Standard & Outdoor IP55 Sensor

Description	Reference	Unit MRP [₹]
Neo C-Metro 200 degrees wall mount sensor, grey colour	E3751MS3C_GS	7881
Zencelo 110 degrees wall mount sensor, white colour	E84751MS3B_WE	7980
Zencelo 90 degrees wall mount sensor, white colour	E84751MS3A_WE	6085
Argus 110 Electronic outdoor movement detector, angle of detection 110 degrees, max. range 12 mtrs, IP55 protection	MTN565119	8688
Argus 220 Electronic movement detector for outdoor ceiling mounting angle of detection 220 degrees, max. range 12 mtrs, IP55 protection	MTN565219	13406

Hotel - ELV Dual Motion Sensor

Description	Reference	Unit MRP [₹]
ELV DUAL TECH MOTION SENSOR	SAE_UE_MS_CULV_WE	11022

Please contact Customer Care Center for Stockable and Non stockable status of references.
*Bold references are MTO reference.

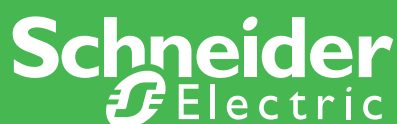

Schneider Electric India Pvt. Ltd.

Corporate Office: 15th Floor, DT-4 Downtown, DLF Phase 3, Sector 25A, Gurugram, Haryana - 122002

Ahmedabad

Schneider Electric India (P) Ltd.
1506-1507, 15th Floor Shapth-5
Opp.Karnavati Club, SG Highway,
Ahmedabad, Gujarat - 380015
Tel.: 079-66826701

Bengaluru

Schneider Electric India (P) Ltd.
No. 3/1, JP Techno Park
Mezzanine Floor, Millers Tank Bund
Road, Vasanth Nagar
Bengaluru - 560052
Tel.: 080-71481351

Bhubaneswar

Schneider Electric India (P) Ltd.
Workloop Co-Working in the property
Office No. 316, Esplanade One Mall
Rasulgarh, Bhubaneswar - 751010

Chennai

Schneider Electric India (P) Ltd.
No: 29, 2nd Floor,
Bannari Amman Towers, B-Block
Dr. Radhakrishnan Road, Mylapore
Chennai - 600 004
Tel.:044-71912000

Cochin

Schneider Electric India (P) Ltd.
Alapatt Properties Private Limited
(Trade Name: Centre A)
Main Door Number: 66/4971
(Old Door Number: 40/6584-H)
7th Floor Alapatt Heritage Building
MG Road Kochi - 682035

Coimbatore

Schneider Electric India Pvt. Ltd.
Mikro Grafeo Services Pvt Ltd.,
Elysium Tower, #21, A.T.T
Colony, Near Honda Office,
Coimbatore, Tamil Nadu - 641018

Hyderabad

Schneider Electric Pvt. Ltd.
4B-4th Floor, Gumidelli Towers,
Prakash Nagar, Begumpet,
Hyderabad - 500016

Indore

Schneider Electric India (P) Ltd.
219, Dhan Trident Building
Vijay Nagar, A.B.Road
Indore - 452001

Jaipur

Schneider Electric India (P) Ltd.
Jaipur Business Centre 309
3rd Floor, Sangam Tower 190
Church Road, Jaipur - 302001
Tel.: 0141-2374810

Kolkata

Schneider Electric (I) Pvt. Ltd.
BN3, Salt Lake, Sector V,
Kolkata - 700091

Lucknow

Schneider Electric India (P) Ltd.
Summit, Plot No. TCG 3/3
6th Floor, 604A/B/C, Vibhuti Khand
Gomti Nagar, Lucknow
Uttar Pradesh - 226010
Tel.: 0522-3500334

Ludhiana

Schneider Electric India (P) Ltd.
SCO 23, 2nd Floor,
Chandigarh Road, Sector 32
Ludhiana, Punjab -141010
Tel.: 0161- 5203011

Mohali

Schneider Electric India (P) Ltd.
2nd Floor, Tower-A
Bestech Business Tower
Mega Information & Technology Park
Industrial Plot No.1, Phase IX
(Expansion), Mohali - 160059
Tel.: 0172-7198200

Mumbai

Schneider Electric India Pvt. Ltd.
L&T Business Park, Tower B,
7th Floor, TC-II, Gate No.5,
Saki Vihar Road, Powai,
Mumbai - 400072

Nagpur

Schneider Electric India (P) Ltd.
6, Vasant Vihar Complex
W.H.C Road, Shankar Nagar
Nagpur - 440010
Tel.: 0712-2558581

Nashik

Schneider Electric India (P) Ltd.
401, 4th Floor, Rishi Raj Towers
Jehan Circle, Gangapur Road
Nashik - 422013
Tel.: 0253-2344333

New Delhi

Schneider Electric India (P) Ltd.
C-56, Mayapuri Industrial Area, Phase-2
New Delhi - 110064
Tel.: 011-61317400

Pune

Schneider Electric India (P) Ltd.
Amar Caliber, CTS No 911, BMCC Road,
OFF F.C. Road, Deccan Gymkhana,
Shivaji Nagar, Pune - 411007
Tel.: 020-67492500

Vadodara

Schneider Electric India (P) Ltd.
Notus IT Park, 10th Floor, Block-D
Sarabhai Campus, Vadiwadi
Vadodara, Gujarat - 390017

Vishakhapatnam

Schneider Electric India (P) Ltd.
D.N.10-1-43, 1st Floor
Ratnam's Business Centre,
Siripuram Fort, C.B.M.Compound
Visakhapatnam - 530016
Tel.: 0891-6675500

Customer Care Centre

Monday-Saturday, 9 a.m. to 8 p.m.

Toll-free numbers: 1800 419 4272, 1800 103 0011

Email: customercare.in@schneider-electric.com

For more information, visit our website at: www.se.com/in

- All Prices are in Indian Rupees
- Prices are subject to change without prior notice
- Product evolution is a continuous process and Schneider Electric reserves the right to modify/withdraw any product at any time without prior notice
- Prices charged will be as prevailing on the date of dispatch
- Invoice Amount = (MRP – less Applicable discount) + Applicable GST %
- Tax incidence on invoices is basis applicable GST rates
- Invoice amount not to exceed MRP
- Product pictures shown are for illustration purpose only; actual product may vary
- Kindly refer product datasheet for detailed specification
- SE recommends to procure products from our authorized sellers only, list of our authorized sellers can be found on <https://www.se.com/in/en/work/support/locator/partner-map/>

Distributor